

**Wuerth Industrial Services Malaysia**

# **BITS & ACCESSORIES**

**Small bits, big impact**



# CONTENT

<b>ALWAYS THE RIGHT BIT</b>	<b>3</b>
<b>COLOUR-CODING SYSTEM</b>	<b>6</b>
<b>BITS</b>	<b>13</b>
<b>BIT ASSORTMENTS</b>	<b>34</b>
<b>BIT HOLDER</b>	<b>53</b>
<b>CONNECTION PIECES &amp; SOCKET WRENCH BLADES</b>	<b>59</b>

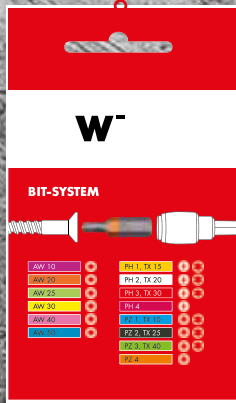

**ALWAYS THE  
RIGHT BIT**

# IF THE COLOR MATCHES, THE BIT FITS.

## Honestly:

How often have you confused a PH bit with a PZ bit or simply chosen the wrong bit size when using your cordless screwMountr? How many times did you have to return to your workbench to get the right bit? Those of you who work with bits know this scenario very well.

The Würth color code – a registered utility model since 1982 – allows you to quickly and easily find the matching bit for a certain screw. At one glance, the label on the screw package shows you the color of the bit

you need. Thanks to the eye-catching colors, you can match bit and screw quickly without having to read the text.

Bits have one unpleasant characteristic: They are always missing when you need them urgently. In this case, one of our more than 330 shops close to you will help you quickly and easily.



Tools and screws with a  
color code.

# THE WUERTH BIT SYSTEM: THE ENDURANCE ATHLETE OF SCREW ASSEMBLY TOOLS

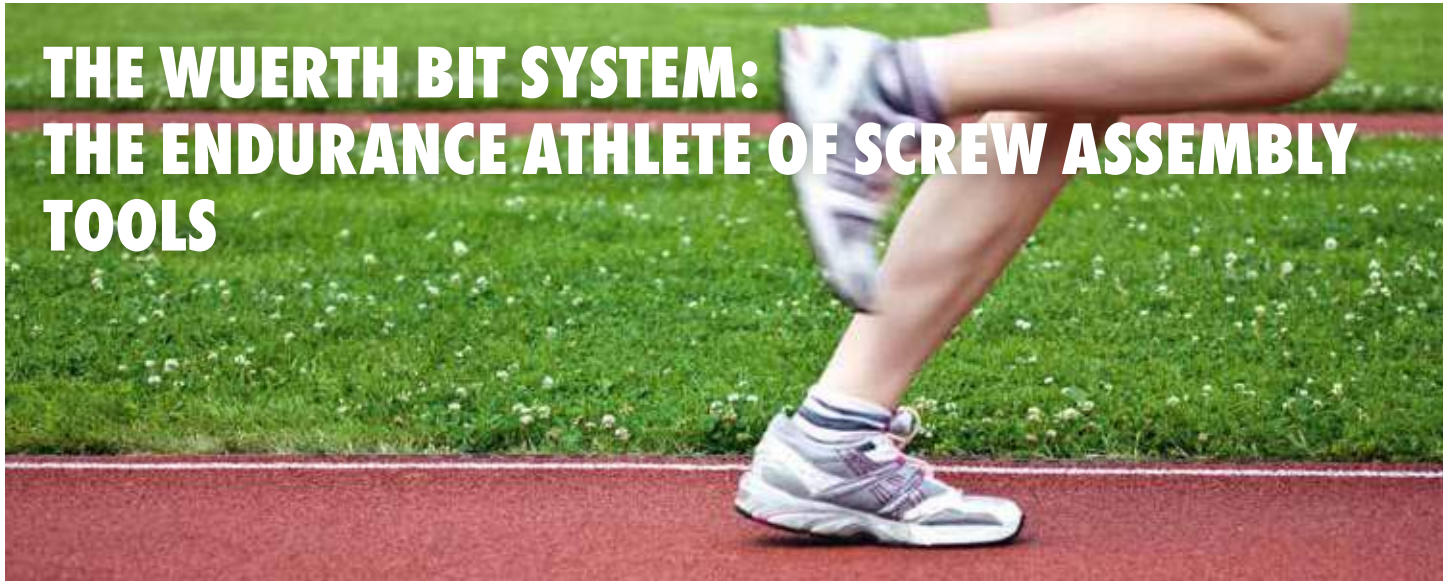

A conventional bit in a conventional bit holder is like an athlete with a wooden leg: Every load peak is conveyed without dampening on impact and quickly leads to breakage. In contrast, the ZEBRA® bit system works like a well-trained athlete: The ZEBRA® bit holder absorbs load peaks like leg muscle on impact. If the load capacity is exceeded, the ZEBRA® bit

itself comes into play: Like the shin, it can cushion additional peaks.

**The result:** ZEBRA® bits last far longer than conventional screw inserts in many applications and thus significantly reduce the costs per bolt connection.



### Now the bit plays its part:

Thanks to an innovative hardening procedure, the bit can also absorb load peaks in the centre area. As a result, bit tip breakages appear much later than in conventional screw inserts.



### A spring, which has been subtly integrated into the bit holder, absorbs load peaks:

The bit holder interior rotates imperceptibly and invisibly as well. When the spring force is exceeded, the bit holder stops to prevent damage to the mechanism.

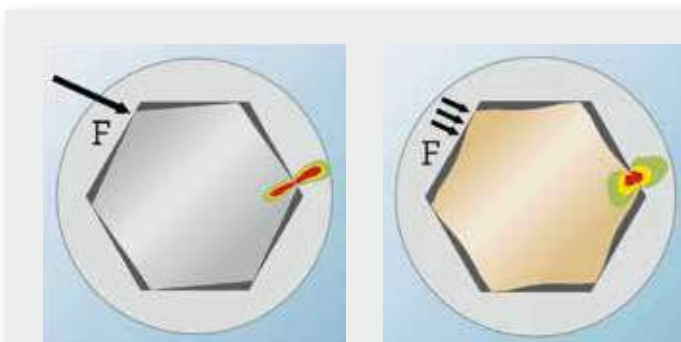

The connection between bit holder and bit insert has also been optimised. The proven Powerdriv® system increases the contact surface of the bit in the holder. The service life of the entire system is increased again.

The figure shows the comparison between the surface contact of the POWERDRIV® profile (right) compared to the line contact of a conventional hexagon profile (left).



# COLOUR-CODING SYSTEM



## ALWAYS THE RIGHT BIT

### Tip: If the color matches, the bit fits.

Tools and screws with a color code – Only at Wuerth!

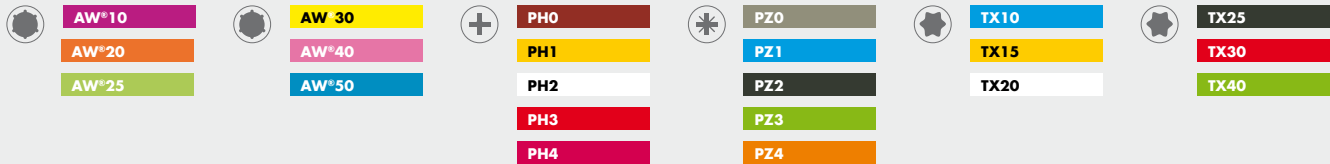

## AW® (AW®)

Mount	AW®10	AW®20	AW®25	AW®30	AW®40	AW®50
C6.3 (1/4")	25 mm p. 14	25 mm p. 14	25 mm p. 14	25 mm p. 14	25 mm p. 14	
E6.3 (1/4")	50-110 mm p. 14-15	50-176.5 mm p. 14-16	50-110 mm p. 14-15	50-110 mm p. 14-15	50-70 mm p. 14	
C8 (5/16")		32 mm p. 14	32 mm p. 14	32 mm p. 14	32 mm p. 14	50 mm p. 15
G7 (7.0 mm)	53 mm p. 16	53 mm p. 16	53 mm p. 16			
M4 thread	45 mm p. 17	33-45 mm p. 16-17	45 mm p. 17			
M5 thread	33-45 mm p. 16-17	33-45 mm p. 16-17	33 mm p. 16			
M6 thread		33-45 mm p. 16-17	33-45 mm p. 16-17			

### AW® Mount system:

- Largest possible contact surface
- Optimum centring
- Improved force transfer

## SLOTTED (SZ)

Mount	SZ 0.5 x 3.0	SZ 0.6 x 3.5	SZ 0.6 x 4.5	SZ 0.8 x 4.0	SZ 0.8 x 5.0
C6.3 (1/4")	25 mm p. 21		25 mm p. 21		
E6.3 (1/4")		73 mm p. 21		73 mm p. 21	73 mm p. 21

Mount	SZ 0.8 x 5.5	SZ 1.0 x 6.0	SZ 1.2 x 6.5	SZ 1.2 x 8.0
C6.3 (1/4")	25 mm p. 21	25 mm p. 21	25 mm p. 21	25 mm p. 21

## ALWAYS THE RIGHT BIT

### + CROSS-RECESS (PH)

Mount	PH0	PH1	PH2	PH3	PH4
C6.3 (1/4")	25 mm p. 22	25-50 mm p. 22-24	25-50 mm p. 22-24	25-50 mm p. 22-24	32 mm p. 22
E6.3 (1/4")		50-90 mm p. 25-26	50-176.5 mm p. 24-26	50-110 mm p. 25-26	
C8 (5/16")			25-50 mm p. 24-26	25-50 mm p. 32	32 mm p. 23
A5.5 (5.5 mm)					
G7 (7.0 mm)		53 mm p. 24	53 mm p. 24	53 mm p. 24	
hexagon 10.0 mm		30 mm p. 22	30 mm p. 22		

### \* CROSS-RECESS (PZ), \* CROSS-RECESS/SLOTTED (PZ/SZ)

Mount	PZ0	PZ1	PZ2	PZ3	PZ4	PZ/SZ1	PZ/SZ2
C6.3 (1/4")	25 mm p. 22	25-50 mm p. 22-24	25-50 mm p. 22-24	25-50 mm p. 22-24	32 mm p. 22-24		
E6.3 (1/4")		50-90 mm p. 24-25	50-168 mm p. 24-25	50-110 mm p. 24-25		73 mm p. 25	73 mm p. 25
C8 (5/16")				32 mm p. 23			
A5.5 (5.5 mm)		50 mm p. 24	50 mm p. 24	50 mm p. 24			
G7 (7.0 mm)		53 mm p. 24	53 mm p. 24	53 mm p. 24			

#### Legend

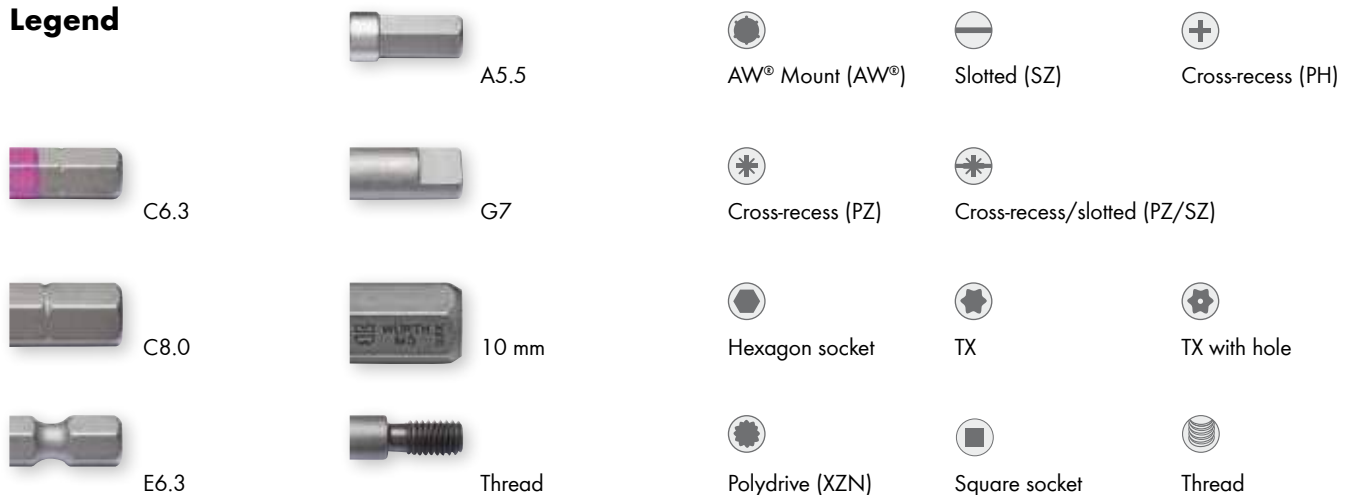



**HEXAGON SOCKET (SW)**

Mount	SW2	SW2.5	SW3	SW4	SW5	SW6	SW 1/4"	SW7
<b>C6.3 (1/4")</b>	25 mm <b>p. 19</b>	25 mm <b>p. 19</b>	25 mm <b>p. 19</b>	25 mm <b>p. 19</b>	25 mm <b>p. 19</b>	25 mm <b>p. 19</b>	25 mm <b>p. 19</b>	25 mm <b>p. 19</b>
<b>E6.3 (1/4")</b>				100 mm <b>p. 20</b>	100 mm <b>p. 20</b>	100 mm <b>p. 20</b>		
<b>C8 (5/16")</b>				50 mm <b>p. 20</b>	50 mm <b>p. 20</b>	50 mm <b>p. 20</b>		50 mm <b>p. 20</b>
<b>hexagon (10.0 mm)</b>					30 mm <b>p. 20</b>	30 mm <b>p. 20</b>		30 mm <b>p. 20</b>

Mount	SW8	SW10	SW12
<b>C6.3 (1/4")</b>			
<b>E6.3 (1/4")</b>			
<b>C8 (5/16")</b>	50 mm <b>p. 20</b>	50 mm <b>p. 20</b>	50 mm <b>p. 20</b>
<b>hexagon (10.0 mm)</b>	30 mm <b>p. 20</b>	30 mm <b>p. 20</b>	30 mm <b>p. 20</b>

**With Wuerth POWERDRIV®**  
Curved surfaces for optimum power transmission and reduced load on screw and bit.

**TX**

Mount	TX6	TX7	TX8	TX9	TX10	TX15	TX20	TX25
<b>C6.3 (1/4")</b>	25 mm <b>p. 27</b>		25 mm <b>p. 27</b>	25 mm <b>p. 27</b>	25 mm <b>p. 27</b>	25 mm <b>p. 27</b>	25-30 mm <b>p. 27</b>	25 mm <b>p. 27</b>
<b>E6.3 (1/4")</b>					70 mm <b>p. 29</b>	70 mm <b>p. 29</b>	70 mm <b>p. 29</b>	70 mm <b>p. 29</b>
<b>C8 (5/16")</b>							50-100 mm <b>p. 28</b>	50-100 mm <b>p. 28</b>
<b>G7 (7 mm)</b>					70 mm <b>p. 29</b>	70 mm <b>p. 29</b>	70 mm <b>p. 29</b>	70 mm <b>p. 29</b>
<b>hexagon (10 mm)</b>							75 mm <b>p. 29</b>	75 mm <b>p. 29</b>

Mount	TX27	TX30	TX40	TX45	TX50	TX55	TX60
<b>C6.3 (1/4")</b>	25 mm <b>p. 27</b>	25-30 mm <b>p. 27</b>	25 mm <b>p. 27</b>	25-30 mm <b>p. 27</b>	35 mm <b>p. 27</b>		
<b>E6.3 (1/4")</b>							
<b>C8 (5/16")</b>	50 mm <b>p. 28</b>	50-100 mm <b>p. 28</b>	50-100 mm <b>p. 28</b>	35-100 mm <b>p. 27-28</b>	35-100 mm <b>p. 27-28</b>	35 mm <b>p. 27</b>	
<b>G7 (7 mm)</b>		70 mm <b>p. 29</b>					
<b>hexagon (10 mm)</b>	75 mm <b>p. 29</b>	75 mm <b>p. 29</b>	75-120 mm <b>p. 29</b>	75-120 mm <b>p. 29</b>	75-120 mm <b>p. 29</b>	75-120 mm <b>p. 29</b>	

## ALWAYS THE RIGHT BIT

### TX WITH HOLE

Mount	TX8	TX9	TX10	TX15	TX20	TX25	TX27	TX30
C6.3 (1/4")	25 mm p. 30	25 mm p. 30	25 mm p. 30	25 mm p. 30	25 mm p. 30	25 mm p. 30	25 mm p. 30	25 mm p. 30
E6.3 (1/4")			70 mm p. 30	70 mm p. 30	70 mm p. 30	70 mm p. 30		70 mm p. 30
hexagon (10 mm)					30 mm p. 30	30 mm p. 30	30 mm p. 30	30 mm p. 30

Mount	TX40	TX45	TX50	TX55
C6.3 (1/4")	25 mm p. 18	25 mm p. 18		
C8 (5/16")				
hexagon (10 mm)	30 mm p. 18	30 mm p. 18	30 mm p. 18	30 mm p. 18



### POLYDRIVE (XZN)

Mount	XZN M4	XZN M5	XZN M6	XZN M8	XZN M10	XZN M12
C6.3 (1/4")	25 mm p. 18	25 mm p. 18	25 mm p. 18	25 mm p. 18		
C8 (5/16")		50 mm p. 18	50 mm p. 18	50 mm p. 18		50 mm p. 18
hexagon (10 mm)		30 mm p. 18	30-75 mm p. 18	30-75 mm p. 18	30-75 mm p. 18	30-75 mm p. 18

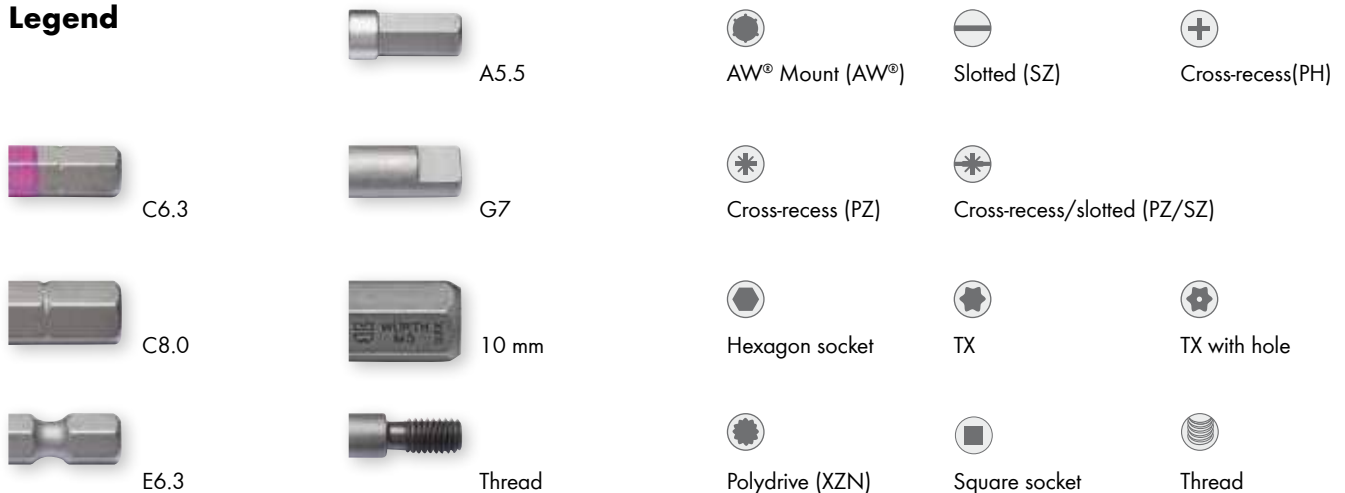
#### Legend





**WEDGE SHAPE (RI)**



Mount	M5	M6	M7	M8	M9
 <b>C6.3 (1/4")</b>	25 mm <b>p. 31</b>	25 mm <b>p. 31</b>	25 mm <b>p. 31</b>	25 mm <b>p. 31</b>	
 <b>hexagon (10 mm)</b>	30-75 mm <b>p. 31</b>	30-75 mm <b>p. 31</b>	30 mm <b>p. 31</b>	30-75 mm <b>p. 31</b>	30 mm <b>p. 31</b>

Mount	M10	M12	M13	M14
 <b>hexagon (10 mm)</b>	30-75 mm <b>p. 31</b>	30 mm <b>p. 31</b>	30 mm <b>p. 31</b>	30 mm <b>p. 31</b>



**SPANNER**

Mount	4	6	8	10
 <b>C6.3 (1/4")</b>	25 mm <b>p. 32</b>	25 mm <b>p. 32</b>	25 mm <b>p. 32</b>	25 mm <b>p. 32</b>
 <b>E6.3 (1/4")</b>		70 mm <b>p. 32</b>	70 mm <b>p. 32</b>	

**TRI-WING**

Mount	1	2	3	4
 <b>C6.3 (1/4")</b>	25 mm <b>p. 32</b>	25 mm <b>p. 32</b>	25 mm <b>p. 32</b>	25 mm <b>p. 32</b>
 <b>E6.3 (1/4")</b>	70 mm <b>p. 32</b>	70 mm <b>p. 32</b>		

**TORQ**

Mount	6	8	10
 <b>C6.3 (1/4")</b>	25 mm <b>p. 32</b>	25 mm <b>p. 32</b>	25 mm <b>p. 32</b>

## ALWAYS THE RIGHT BIT

### **HEXAGON SOCKET INCH**

Mount	1/8"	9/64"	5/32"	3/16"
<b>C6.3 (1/4")</b>	25 mm <b>p. 32</b>	25 mm <b>p. 32</b>	25 mm <b>p. 32</b>	25 mm <b>p. 32</b>

### **HEXAGON SOCKET WITH HOLE**

Mount	2	2.5	3	4
<b>C6.3 (1/4")</b>	25 mm <b>p. 33</b>	25 mm <b>p. 33</b>	25 mm <b>p. 33</b>	25 mm <b>p. 33</b>

### **SQUARE SOCKET**

Mount	1	2	3	4
<b>C6.3 (1/4")</b>	25 mm <b>p. 33</b>	25 mm <b>p. 33</b>	25 mm <b>p. 33</b>	25 mm <b>p. 33</b>

### **CLUTCH**

Mount	3/32"	1/8"	5/32"
<b>C6.3 (1/4")</b>	25 mm <b>p. 33</b>	25 mm <b>p. 33</b>	25 mm <b>p. 33</b>

### **FIVE STAR WITH HOLE**

Mount	20	25	30
<b>E6.3 (1/4")</b>	70 mm <b>p. 33</b>	70 mm <b>p. 33</b>	70 mm <b>p. 33</b>

#### Legend



C8.0



E6.3

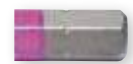

C6.3



A5.5



G7



10 mm



Thread



Hexagon socket



Hexagon socket with hole



Square socket



Spanner



Torq



Tri-wing



Clutch



Five star



Wedge shape

# **BITS**



# BITS

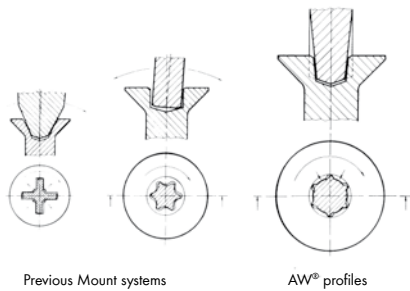

## Advantages of the AW® Mount system:

- Improved force transfer
- Longer service life
- Optimum centring
- Largest possible contact surface of bit in screw mount
- Even distribution of force results in hardly any ejection forces
- Prevention of damages at the screw, thus higher corrosion protection

## AW®, 25 MM



Image in original size



C6.3



Mount	Dimensions	Length	Art. No.	PU.
¼" hexagon	AW®10	25 mm	<b>0614 125 10</b>	10
¼" hexagon	AW®20	25 mm	<b>0614 125 20</b>	10
¼" hexagon	AW®25	25 mm	<b>0614 125 25</b>	10
¼" hexagon	AW®30	25 mm	<b>0614 125 30</b>	10



Image in original size

C6.3



Mount	Dimensions	Length	Art. No.	PU.
¼" hexagon	AW®10	25 mm	<b>0614 511 0</b>	10/100
¼" hexagon	AW®20	25 mm	<b>0614 512 0</b>	10/100
¼" hexagon	AW®25	25 mm	<b>0614 512 5</b>	10/100
¼" hexagon	AW®30	25 mm	<b>0614 513 0</b>	10/100
¼" hexagon	AW®40	25 mm	<b>0614 514 0</b>	10

## AW®, 32 MM



Image in original size

C8.0



Mount	Dimensions	Length	Art. No.	PU.
¼" hexagon	AW®20	32 mm	<b>0614 552 0</b>	5
¼" hexagon	AW®25	32 mm	<b>0614 552 5</b>	5
¼" hexagon	AW®30	32 mm	<b>0614 553 0</b>	5
¼" hexagon	AW®40	32 mm	<b>0614 554 0</b>	5

## AW®, 50 MM



Image in original size

E6.3



Mount	Dimensions	Length	Art. No.	PU.
¼" hexagon	AW®10	50 mm	<b>0614 521 0</b>	5
¼" hexagon	AW®20	50 mm	<b>0614 522 0</b>	5
¼" hexagon	AW®25	50 mm	<b>0614 522 5</b>	5
¼" hexagon	AW®30	50 mm	<b>0614 523 0</b>	5
¼" hexagon	AW®40	50 mm	<b>0614 524 0</b>	5

**AW®, 50 MM**

Image in original size

**C8.0**

Mount	Dimensions	Length	Art. No.	PU.
5/16" hexagon	AW®50	50 mm	<b>0614 550 50</b>	5

**AW®, 110 MM**

Image in original size

**C8.0**

Mount	Dimensions	Length	Art. No.	PU.
5/8" hexagon	AW®50	110 mm	<b>0614 550 110</b>	5

**AW®, 70 MM**

Image in original size

**E6.3**

Mount	Dimensions	Length	Art. No.	PU.
1/4" hexagon	AW®10	70 mm	<b>0614 571 0</b>	5
1/4" hexagon	AW®20	70 mm	<b>0614 572 0</b>	5
1/4" hexagon	AW®30	70 mm	<b>0614 573 0</b>	5
1/4" hexagon	AW®40	70 mm	<b>0614 574 0</b>	5

**AW®, 110 MM**

Image in original size

**E6.3**

Mount	Dimensions	Length	Art. No.	PU.
1/4" hexagon	AW®10	110 mm	<b>0614 581 0</b>	5
1/4" hexagon	AW®20	110 mm	<b>0614 582 0</b>	5
1/4" hexagon	AW®25	110 mm	<b>0614 582 5</b>	5
1/4" hexagon	AW®30	110 mm	<b>0614 583 0</b>	5

**AW®, 155 MM**

Image in original size

**E6.3**

Mount	Dimensions	Length	Art. No.	PU.
1/4" hexagon	AW®20	155 mm	<b>0614 100 220</b>	3

# BITS

## **AW<sup>®</sup>, 168 MM**



Image in original size



Mount	Dimensions	Length	Art. No.	PU.
¼" Slotted	AW <sup>®</sup> 20	168 mm	<b>0614 100 320</b>	3

## **AW<sup>®</sup>, 176.5 MM**



Image in original size



Mount	Dimensions	Length	Art. No.	PU.
¼" hexagon	AW <sup>®</sup> 20	176.5 mm	<b>0614 100 420</b>	3

## **AW<sup>®</sup>, 53 MM**

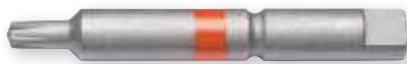

Image in original size



Mount	Dimensions	Length	Art. No.	PU.
7 mm, thread	AW <sup>®</sup> 10	53 mm	<b>0614 531 0</b>	5
7 mm, thread	AW <sup>®</sup> 20	53 mm	<b>0614 532 0</b>	5
7 mm, thread	AW <sup>®</sup> 25	53 mm	<b>0614 532 5</b>	5

## **AW<sup>®</sup>, 33 MM**



Image in original size



Mount	Dimensions	Length	Art. No.	PU.
M4 thread	AW <sup>®</sup> 20	33 mm	<b>0614 432 0</b>	5



Image in original size



Mount	Dimensions	Length	Art. No.	PU.
M5 thread	AW <sup>®</sup> 10	33 mm	<b>0614 561 0</b>	5
M5 thread	AW <sup>®</sup> 20	33 mm	<b>0614 562 0</b>	5
M5 thread	AW <sup>®</sup> 25	33 mm	<b>0614 562 5</b>	5



Image in original size



Mount	Dimensions	Length	Art. No.	PU.
M6 thread	AW <sup>®</sup> 20	33 mm	<b>0614 612 0</b>	5
M6 thread	AW <sup>®</sup> 25	33 mm	<b>0614 612 5</b>	5



**AW<sup>®</sup>, 45 MM**

Image in original size



Image in original size



Image in original size



Mount	Dimensions	Length	Art. No.	PU.
M4 thread	AW <sup>®</sup> 10	45 mm	<b>0614 441 0</b>	5
M4 thread	AW <sup>®</sup> 20	45 mm	<b>0614 442 0</b>	5



Mount	Dimensions	Length	Art. No.	PU.
M5 thread	AW <sup>®</sup> 10	45 mm	<b>0614 541 0</b>	5
M5 thread	AW <sup>®</sup> 20	45 mm	<b>0614 542 0</b>	5



Mount	Dimensions	Length	Art. No.	PU.
M6 thread	AW <sup>®</sup> 20	45 mm	<b>0614 622 0</b>	5
M6 thread	AW <sup>®</sup> 25	45 mm	<b>0614 622 5</b>	5

**BITS**
**POLYDRIVE, 25 MM**

Image in original size

**C6.3**

Mount	Set/Size	Length	Art. No.	PU.
1/4" hexagon	M4, M5, M6, M8	25 mm	<b>0614 250 305</b>	1

**POLYDRIVE, 50 MM**

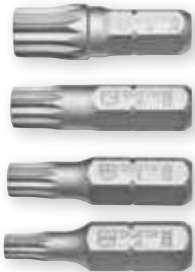
Image in original size

**C8.0**

Mount	Dimensions	Length	Art. No.	PU.
5/16" hexagon	M5	50 mm	<b>0614 786 055</b>	1/5
5/16" hexagon	M6	50 mm	<b>0614 786 065</b>	1/5
5/16" hexagon	M8	50 mm	<b>0614 786 085</b>	1/5
5/16" hexagon	M12	50 mm	<b>0614 786 125</b>	1/5

**POLYDRIVE, 30 MM**

Image in original size

**10 mm**

Mount	Dimensions	Length	Art. No.	PU.
10 mm, hexagon	M5	30 mm	<b>0614 788 405</b>	1/5
10 mm, hexagon	M6	30 mm	<b>0614 788 406</b>	1/5
10 mm, hexagon	M7	30 mm	<b>0614 788 607</b>	1/5
10 mm, hexagon	M8	30 mm	<b>0614 788 408</b>	1/5
10 mm, hexagon	M10	30 mm	<b>0614 788 410</b>	1/5
10 mm, hexagon	M12	30 mm	<b>0614 788 412</b>	1/5

**POLYDRIVE, 75 MM**

Image in original size

**10 mm**

Mount	Dimensions	Length	Art. No.	PU.
10 mm, hexagon	M6	75 mm	<b>0614 788 506</b>	1/5
10 mm, hexagon	M8	75 mm	<b>0614 788 508</b>	1/5
10 mm, hexagon	M10	75 mm	<b>0614 788 510</b>	1/5
10 mm, hexagon	M12	75 mm	<b>0614 788 512</b>	1/5

**1. Without POWERDRIV®**

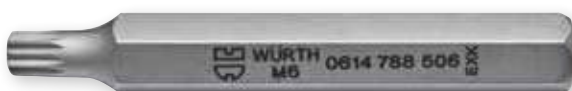
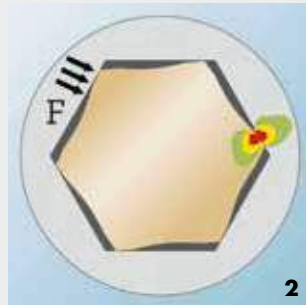
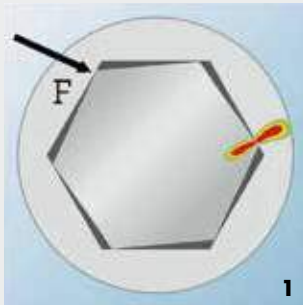
Force is exerted only at individual points (see arrow).  
The consequence: high point load on screw and bit  
(see red area).

**2. With POWERDRIV®**

Force is distributed across the curved surfaces on each side of the hexagon (see arrow). This reduces the load on the screw and bit  
(see red area).

**HEXAGON SOCKET, 25 MM**

Image in original size

**C6.3**

Mount	Dimensions	Length	Art. No.	PU.
¼" hexagon	SW2	25 mm	<b>0614 176 92</b>	5
¼" hexagon	SW2.5	25 mm	<b>0614 176 925</b>	5
¼" hexagon	SW3	25 mm	<b>0614 176 93</b>	5
¼" hexagon	SW4	25 mm	<b>0614 176 94</b>	5
¼" hexagon	SW5	25 mm	<b>0614 176 95</b>	5
¼" hexagon	SW6	25 mm	<b>0614 176 96</b>	5
¼" hexagon	SW¼"	25 mm	<b>0614 176 963</b>	5
¼" hexagon	SW7	25 mm	<b>0614 176 97</b>	5

**HEXAGON SOCKET, 25 MM**

Image in original size

**C6.3**

Mount	Dimensions	Length	Art. No.	PU.
¼" hexagon	SW2	25 mm	<b>0614 176 082</b>	5

## BITS

### **HEXAGON SOCKET, 30 MM**



Image in original size

10 mm

Mount	Dimensions	Length	Art. No.	PU.
10 mm, hexagon	SW5	30 mm	<b>0614 788 305</b>	1/5
10 mm, hexagon	SW6	30 mm	<b>0614 788 306</b>	1/5
10 mm, hexagon	SW7	30 mm	<b>0614 788 307</b>	1/5

10 mm

Mount	Dimensions	Length	Art. No.	PU.
10 mm, hexagon	SW8	30 mm	<b>0614 788 308</b>	1/5
10 mm, hexagon	SW10	30 mm	<b>0614 788 310</b>	1/5
10 mm, hexagon	SW12	30 mm	<b>0614 788 312</b>	1/5

### **HEXAGON SOCKET, 50 MM**



C8.0

Image in original size

Mount	Dimensions	Length	Art. No.	PU.
5/16" hexagon	SW4	50 mm	<b>0614 784 045</b>	5
5/16" hexagon	SW5	50 mm	<b>0614 784 055</b>	5
5/16" hexagon	SW6	50 mm	<b>0614 784 065</b>	5
5/16" hexagon	SW7	50 mm	<b>0614 784 075</b>	5
5/16" hexagon	SW8	50 mm	<b>0614 784 085</b>	5
5/16" hexagon	SW10	50 mm	<b>0614 784 105</b>	5
5/16" hexagon	SW12	50 mm	<b>0614 784 125</b>	5

### **HEXAGON SOCKET, 100 MM**



Image in original size

E6.3

Mount	Dimensions	Length	Art. No.	PU.
1/4" hexagon	SW4	100 mm	<b>0614 176 854</b>	5
1/4" hexagon	SW5	100 mm	<b>0614 176 855</b>	5
1/4" hexagon	SW6	100 mm	<b>0614 176 856</b>	5

**SLOTTED, 25 MM**

Image in original size

**C 6.3** 

Mount	Dimensions	Length	Art. No.	PU.
1/4" hexagon	0.5x3.0	25 mm	<b>0614 175 650</b>	1/10
1/4" hexagon	0.6x4.5	25 mm	<b>0614 175 652</b>	1/10
1/4" hexagon	0.8x5.5	25 mm	<b>0614 175 653</b>	1/10
1/4" hexagon	1.0x6.0	25 mm	<b>0614 175 654</b>	1/10
1/4" hexagon	1.2x6.5	25 mm	<b>0614 175 655</b>	1/10
1/4" hexagon	1.2x8.0	25 mm	<b>0614 175 656</b>	1/10

**SLOTTED, 73 MM**

Image in original size

**E6.3** 

Mount	Dimensions	Length	Art. No.	PU.
1/4" hexagon	0.6x3.5	73 mm	<b>0614 175 660</b>	5
1/4" hexagon	0.8x4.0	73 mm	<b>0614 175 661</b>	5
1/4" hexagon	0.8x5.0	73 mm	<b>0614 175 662</b>	5
1/4" hexagon	1.0x6.0	73 mm	<b>0614 175 663</b>	5

**BITS**
**CROSS-RECESS, PH AND PZ, 25 MM**

Image in original size



C6.3

Mount	Dimensions	Length	Art. No.	PU.
1/4" hexagon	PH1	25 mm	<b>0614 122 51</b>	10
1/4" hexagon	PH2	25 mm	<b>0614 122 52</b>	10
1/4" hexagon	PH3	25 mm	<b>0614 122 53</b>	10
1/4" hexagon	PZ1	25 mm	<b>0614 112 51</b>	10
1/4" hexagon	PZ2	25 mm	<b>0614 112 52</b>	10
1/4" hexagon	PZ3	25 mm	<b>0614 112 53</b>	10



Image in original size

C6.3

Mount	Dimensions	Length	Art. No.	PU.
1/4" hexagon	PH0	25 mm	<b>0614 176 270</b>	5
1/4" hexagon	PH1	25 mm	<b>0614 176 274</b>	10/100
1/4" hexagon	PH2	25 mm	<b>0614 176 461</b>	10/100
1/4" hexagon	PH3	25 mm	<b>0614 176 648</b>	10
1/4" hexagon	PH4	32 mm	<b>0614 176 750</b>	5
1/4" hexagon	PZ0	25 mm	<b>0614 176 640</b>	5
1/4" hexagon	PZ1	25 mm	<b>0614 176 651</b>	10/100
1/4" hexagon	PZ2	25 mm	<b>0614 176 652</b>	10/100
1/4" hexagon	PZ3	25 mm	<b>0614 176 653</b>	10
1/4" hexagon	PZ4	32 mm	<b>0614 176 751</b>	5

**CROSS-RECESS, PH AND PZ, 25 MM**

Image in original size



C6.3

Mount	Dimensions	Length	Art. No.	PU.
1/4" hexagon	PH1	29 mm	<b>0614 176 275</b>	5
1/4" hexagon	PH2	29 mm	<b>0614 176 462</b>	5
1/4" hexagon	PH3	29 mm	<b>0614 176 647</b>	5
1/4" hexagon	PZ1	29 mm	<b>0614 176 641</b>	5
1/4" hexagon	PZ2	29 mm	<b>0614 176 642</b>	5
1/4" hexagon	PZ3	29 mm	<b>0614 176 643</b>	5

**PHILIPS, PH, 30 MM**

Image in original size

10 mm

Mount	Dimensions	Length	Art. No.	PU.
10 mm, hexagon	PH1	30 mm	<b>0614 788 902</b>	1/5
10 mm, hexagon	PH2	30 mm	<b>0614 788 903</b>	1/5

**+ CROSS-RECESS, PZ, 32 MM**

**C8.0**

Mount	Dimensions	Length	Art. No.	PU.
5/16" hexagon	PH2	32 mm	<b>0614 177 583</b>	5

Image in original size

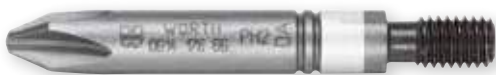
**+ CROSS-RECESS, PH, 45 MM**

**C8.0**

Mount	Dimensions	Length	Art. No.	PU.
11/32" hexagon	PH2	45 mm	<b>0614 176 66</b>	5

Image in original size

**+ CROSS-RECESS, PH, 32 MM**

**C8.0**

Mount	Dimensions	Length	Art. No.	PU.
5/16" hexagon	<b>PH3</b>	32 mm	<b>0614 177 770</b>	5

Image in original size

**+ \* CROSS-RECESS, PH AND PZ, 45 MM**

Mount	Dimensions	Length	Art. No.	PU.
M5	PH2	45 mm	<b>0614 176 662</b>	5
M5	PH2	45 mm	<b>0614 176 679</b>	5
M6	<b>PZ2</b>	45 mm	<b>0614 176 677</b>	5

Image in original size

**BITS**
**CROSS-RECESS, PH AND PZ, 50 MM**

Image in original size

**C 6.3**

Mount	Dimensions	Length	Art. No.	PU.
1/4" hexagon	PH1	50 mm	<b>0614 176 691</b>	5
1/4" hexagon	PH2	50 mm	<b>0614 176 692</b>	5
1/4" hexagon	PH3	50 mm	<b>0614 176 693</b>	5
1/4" hexagon	PZ1	50 mm	<b>0614 176 694</b>	5
1/4" hexagon	PZ2	50 mm	<b>0614 176 695</b>	5
1/4" hexagon	PZ3	50 mm	<b>0614 176 696</b>	5



Image in original size

**A5.5**

Mount	Dimensions	Length	Art. No.	PU.
5.5 mm, hexagon	PZ1	50 mm	<b>0614 176 654</b>	5
5.5 mm, hexagon	PZ2	50 mm	<b>0614 176 655</b>	5
5.5 mm, hexagon	PZ3	50 mm	<b>0614 176 656</b>	5



Image in original size

**E6.3**

Mount	Dimensions	Length	Art. No.	PU.
1/4" hexagon	PH1	50 mm	<b>0614 176 735</b>	5
1/4" hexagon	PH2	50 mm	<b>0614 176 736</b>	5
1/4" hexagon	PH3	50 mm	<b>0614 176 737</b>	5
1/4" hexagon	PZ1	50 mm	<b>0614 176 659</b>	5
1/4" hexagon	PZ2	50 mm	<b>0614 176 660</b>	5
1/4" hexagon	PZ3	50 mm	<b>0614 176 661</b>	5

**CROSS-RECESS, PH AND PZ, 53 MM**

Image in original size

**G7**

Mount	Dimensions	Length	Art. No.	PU.
7 mm, hexagon	PH1	53 mm	<b>0614 176 740</b>	5
7 mm, hexagon	PH2	53 mm	<b>0614 176 741</b>	5
7 mm, hexagon	PH3	53 mm	<b>0614 176 742</b>	5
7 mm, hexagon	PZ1	53 mm	<b>0614 176 667</b>	5
7 mm, hexagon	PZ2	53 mm	<b>0614 176 668</b>	3
7 mm, hexagon	PZ3	53 mm	<b>0614 176 669</b>	5



+ \* **CROSS-RECESS, PH AND PZ, 73 MM**

Image in original size

E6.3



Mount	Dimensions	Length	Art. No.	PU.
1/4" hexagon	PH1	73 mm	<b>0614 176 774</b>	5
1/4" hexagon	PH2	73 mm	<b>0614 176 775</b>	5
1/4" hexagon	PZ1	73 mm	<b>0614 176 776</b>	5
1/4" hexagon	PZ2	73 mm	<b>0614 176 777</b>	5

+ \* **CROSS-RECESS, PH AND PZ, 90 MM**

Image in original size

E6.3



Mount	Dimensions	Length	Art. No.	PU.
1/4" hexagon	PH1	90 mm	<b>0614 176 850</b>	5
1/4" hexagon	PZ1	90 mm	<b>0614 176 852</b>	5

+ \* **CROSS-RECESS, PH AND PZ, 110 MM**

Image in original size

E6.3



Mount	Dimensions	Length	Art. No.	PU.
1/4" hexagon	PH2	110 mm	<b>0614 176 739</b>	3
1/4" hexagon	PH3	110 mm	<b>0614 176 851</b>	5
1/4" hexagon	PZ2	110 mm	<b>0614 176 738</b>	3
1/4" hexagon	PZ3	110 mm	<b>0614 176 853</b>	5

+ \* **CROSS-RECESS, PH AND PZ, 152 MM**

Image in original size

- For magazine screw attachment MSVM2

E6.3



Mount	Dimensions	Length	Art. No.	PU.
1/4" hexagon	PH2	152 mm	<b>0614 100 201</b>	3
1/4" hexagon	PZ2	152 mm	<b>0614 100 221</b>	3

**BITS**
**CROSS-RECESS, PH AND PZ, 155 MM**

Image in original size

- For magazine screw attachment MSVW1

E6.3

Mount	Dimensions	Length	Art. No.	PU.
1/4" hexagon	PH2	155 mm	<b>0614 100 111</b>	3
1/4" hexagon	PZ2	155 mm	<b>0614 100 131</b>	3

**CROSS-RECESS, PH AND PZ, 168 MM**

Image in original size

- For magazine screw attachment MSVW2

E6.3

Mount	Dimensions	Length	Art. No.	PU.
1/4" hexagon	PH2	168 mm	<b>0614 100 211</b>	3
1/4" hexagon	PZ2	168 mm	<b>0614 100 231</b>	3

**CROSS-RECESS, PH AND PZ, 176.5 MM**

Image in original size

- For magazine screw attachment S50-TB

E6.3

Mount	Dimensions	Length	Art. No.	PU.
1/4" hexagon	PH2	176.5 mm	<b>0614 100 212</b>	3

**CROSS-RECESS, PZ AND SLOTTED (PLUS/MINUS), 73 MM**

Image in original size

E6.3

Mount	Dimensions	Length	Art. No.	PU.
1/4" hexagon	PZ1	73 mm	<b>0614 176 791</b>	5
1/4" hexagon	PZ2	73 mm	<b>0614 176 792</b>	5

**TX, 25 MM AND 35 MM**

Image in original size



Image in original size

**C6.3** 

Mount	Dimensions	Length	Art. No.	PU.
¼" hexagon	TX6	25 mm	<b>0614 310 6</b>	10
¼" hexagon	TX7	25 mm	<b>0614 310 7</b>	10
¼" hexagon	TX8	25 mm	<b>0614 310 8</b>	10
¼" hexagon	TX9	25 mm	<b>0614 310 9</b>	10
¼" hexagon	TX10	25 mm	<b>0614 311 0</b>	5/10
¼" hexagon	TX15	25 mm	<b>0614 311 5</b>	5/10
¼" hexagon	TX20	25 mm	<b>0614 312 0</b>	5/10
¼" hexagon	TX20	29 mm	<b>0614 312 03</b>	5
¼" hexagon	TX20	30 mm	<b>0614 788 820</b>	1/5
¼" hexagon	TX25	25 mm	<b>0614 312 5</b>	5/10
¼" hexagon	TX25	30 mm	<b>0614 788 825</b>	1/5
¼" hexagon	TX27	25 mm	<b>0614 312 7</b>	5/10
¼" hexagon	TX30	25 mm	<b>0614 313 0</b>	5/10
¼" hexagon	TX30	30 mm	<b>0614 788 830</b>	1/5
¼" hexagon	TX40	25 mm	<b>0614 314 0</b>	5/10
¼" hexagon	TX40	30 mm	<b>0614 788 840</b>	1/5
¼" hexagon	TX45	25 mm	<b>0614 314 50</b>	5
¼" hexagon	TX45	25 mm	<b>0614 314 51</b>	1/10
¼" hexagon	TX45	30 mm	<b>0614 788 845</b>	1/5
¼" hexagon	TX50	30 mm	<b>0614 788 850</b>	1/5
¼" hexagon	TX50	35 mm	<b>0614 315 01</b>	1/10
¼" hexagon	TX55	30 mm	<b>0614 788 855</b>	1/5

**C8.0** 

Mount	Dimensions	Length	Art. No.	PU.
⅜" hexagon	TX45	35 mm	<b>0614 314 5</b>	1/10
⅜" hexagon	TX50	35 mm	<b>0614 315 0</b>	1/10
⅜" hexagon	TX55	35 mm	<b>0614 315 5</b>	1/10

## BITS

### **TX, 50 MM**



Image in original size

C8.0 

Mount	Dimensions	Length	Art. No.	PU.
5/16" hexagon	TX20	50 mm	<b>0614 787 205</b>	1/5
5/16" hexagon	TX25	50 mm	<b>0614 787 255</b>	1/5
5/16" hexagon	TX27	50 mm	<b>0614 787 275</b>	1/5
5/16" hexagon	TX30	50 mm	<b>0614 787 305</b>	1/5

C8.0 

Mount	Dimensions	Length	Art. No.	PU.
5/16" hexagon	TX40	50 mm	<b>0614 787 405</b>	1/5
5/16" hexagon	TX45	50 mm	<b>0614 787 455</b>	1/5
5/16" hexagon	TX50	50 mm	<b>0614 787 505</b>	1/5
5/16" hexagon	TX55	50 mm	<b>0614 787 555</b>	1

### **TX, 90 MM**



C6.3 

Image in original size

Mount	Dimensions	Length	Art. No.	PU.
1/4" hexagon	TX30	90 mm	<b>0614 344 30</b>	1
1/4" hexagon	TX40	90 mm	<b>0614 344 40</b>	1

### **TX, 100 MM**



Image in original size

C8.0 

Mount	Dimensions	Length	Art. No.	PU.
5/16" hexagon	TX20	100 mm	<b>0614 787 201</b>	1/5
5/16" hexagon	TX25	100 mm	<b>0614 787 251</b>	1/5
5/16" hexagon	TX30	100 mm	<b>0614 787 301</b>	1/5

C8.0 

Mount	Dimensions	Length	Art. No.	PU.
5/16" hexagon	TX40	100 mm	<b>0614 787 401</b>	1/5
5/16" hexagon	TX45	100 mm	<b>0614 787 451</b>	1/5

**TX, 70 MM**

**E6.3**

Image in original size

Mount	Dimensions	Length	Art. No.	PU.
1/4" hexagon	TX10	70 mm	<b>0614 331 0</b>	1/5
1/4" hexagon	TX15	70 mm	<b>0614 331 5</b>	1/5
1/4" hexagon	TX20	70 mm	<b>0614 332 0</b>	1/5
1/4" hexagon	TX25	70 mm	<b>0614 332 5</b>	1/5
1/4" hexagon	TX27	70 mm	<b>0614 332 7</b>	5
1/4" hexagon	TX30	70 mm	<b>0614 333 0</b>	1/5

**G7**

Image in original size

Mount	Dimensions	Length	Art. No.	PU.
7 mm, slotted	TX10	70 mm	<b>0614 341 0</b>	1/5
7 mm, slotted	TX20	70 mm	<b>0614 342 0</b>	1/5
7 mm, slotted	TX25	70 mm	<b>0614 342 5</b>	1/5
7 mm, slotted	TX30	70 mm	<b>0614 343 0</b>	1/5

**TX, 75 MM**

Image in original size

**10 mm**

Mount	Dimensions	Length	Art. No.	PU.
10 mm, hexagon	TX20	75 mm	<b>0614 788 120</b>	1/5
10 mm, hexagon	TX25	75 mm	<b>0614 788 125</b>	1/5
10 mm, hexagon	TX27	75 mm	<b>0614 788 127</b>	1/5
10 mm, hexagon	TX30	75 mm	<b>0614 788 130</b>	1/5

**10 mm**

Mount	Dimensions	Length	Art. No.	PU.
10 mm, hexagon	TX40	75 mm	<b>0614 788 140</b>	1/5
10 mm, hexagon	TX45	75 mm	<b>0614 788 145</b>	1/5
10 mm, hexagon	TX50	75 mm	<b>0614 788 150</b>	1/5
10 mm, hexagon	TX55	75 mm	<b>0614 788 155</b>	1/5

**TX, 120 MM**

Image in original size

**10 mm**

Mount	Dimensions	Length	Art. No.	PU.
10 mm, hexagon	TX40	120 mm	<b>0614 788 240</b>	1/5
10 mm, hexagon	TX45	120 mm	<b>0614 788 245</b>	1/5
10 mm, hexagon	TX50	120 mm	<b>0614 788 250</b>	1/5

## BITS

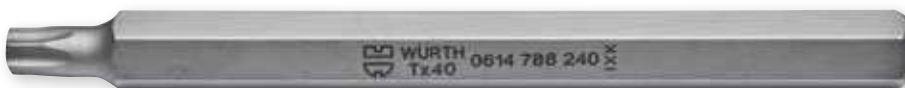
### TX WITH HOLE, 25 MM



Image in original size

C6.3

Mount	Dimensions	Length	Art. No.	PU.
1/4" hexagon	TX8	25 mm	<b>0614 352 608</b>	5
1/4" hexagon	TX9	25 mm	<b>0614 352 609</b>	5
1/4" hexagon	TX10	25 mm	<b>0614 352 610</b>	5
1/4" hexagon	TX15	25 mm	<b>0614 352 615</b>	5
1/4" hexagon	TX20	25 mm	<b>0614 352 620</b>	5



Image in original size

C6.3

Mount	Dimensions	Length	Art. No.	PU.
1/4" hexagon	TX25	25 mm	<b>0614 352 625</b>	5
1/4" hexagon	TX27	25 mm	<b>0614 352 627</b>	5
1/4" hexagon	TX30	25 mm	<b>0614 352 630</b>	5
1/4" hexagon	TX40	25 mm	<b>0614 352 640</b>	5
1/4" hexagon	TX45	25 mm	<b>0614 352 645</b>	5

### TX WITH HOLE, 30 MM



Image in original size

10 mm

Mount	Dimensions	Length	Art. No.	PU.
10 mm, hexagon	TX20	30 mm	<b>0614 788 20</b>	1/5
10 mm, hexagon	TX25	30 mm	<b>0614 788 25</b>	1/5
10 mm, hexagon	TX27	30 mm	<b>0614 788 27</b>	1/5
10 mm, hexagon	TX30	30 mm	<b>0614 788 30</b>	1/5

10 mm

Mount	Dimensions	Length	Art. No.	PU.
10 mm, hexagon	TX40	30 mm	<b>0614 788 40</b>	1/5
10 mm, hexagon	TX45	30 mm	<b>0614 788 45</b>	1/5
10 mm, hexagon	TX50	30 mm	<b>0614 788 50</b>	1/5
10 mm, hexagon	TX55	30 mm	<b>0614 788 55</b>	1/5

### TX WITH HOLE, 35 MM



Image in original size

C8.0

Mount	Dimensions	Length	Art. No.	PU.
5/16" hexagon	TX45	35 mm	<b>0614 353 545</b>	5
5/16" hexagon	TX50	35 mm	<b>0614 353 550</b>	5
5/16" hexagon	TX55	35 mm	<b>0614 353 555</b>	5

### TX WITH HOLE, 70 MM



Image in original size

E6.3

Mount	Dimensions	Length	Art. No.	PU.
1/4" hexagon	TX10	70 mm	<b>0614 371 0</b>	5
1/4" hexagon	TX15	70 mm	<b>0614 371 5</b>	5
1/4" hexagon	TX20	70 mm	<b>0614 372 0</b>	5
1/4" hexagon	TX25	70 mm	<b>0614 372 5</b>	5
1/4" hexagon	TX30	70 mm	<b>0614 373 0</b>	5

**WEDGE SHAPE (RI) BIT, 25 MM**

Image in original size

**C6.3**

Mount	Set/Size	Length	Art. No.	PU.
1/4" hexagon	M5, M6, M7, M8	25 mm	<b>0614 250 307</b>	1

**WEDGE SHAPE (RI) BIT, 30 MM**

Image in original size

**10 mm**

Mount	Dimensions	Length	Art. No.	PU.
10 mm, hexagon	M5	30 mm	<b>0614 788 605</b>	1/5
10 mm, hexagon	M6	30 mm	<b>0614 788 606</b>	1/5
10 mm, hexagon	M7	30 mm	<b>0614 788 607</b>	1/5
10 mm, hexagon	M8	30 mm	<b>0614 788 608</b>	1/5
10 mm, hexagon	M9	30 mm	<b>0614 788 609</b>	1/5

**10 mm**

Mount	Dimensions	Length	Art. No.	PU.
10 mm, hexagon	M10	30 mm	<b>0614 788 610</b>	1/5
10 mm, hexagon	M12	30 mm	<b>0614 788 612</b>	1/5
10 mm, hexagon	M13	30 mm	<b>0614 788 613</b>	1/5
10 mm, hexagon	M14	30 mm	<b>0614 788 614</b>	1/5

**WEDGE SHAPE (RI) BIT, 75 MM**

Image in original size

**10 mm**

Mount	Dimensions	Length	Art. No.	PU.
10 mm, hexagon	M5	75 mm	<b>0614 788 705</b>	1/5
10 mm, hexagon	M6	75 mm	<b>0614 788 706</b>	1/5
10 mm, hexagon	M8	75 mm	<b>0614 788 708</b>	1/5
10 mm, hexagon	M10	75 mm	<b>0614 788 710</b>	1/5

## SPECIAL AND SECURITY BITS

### **SPANNER, 25 MM**



Image in original size

C6.3 

Mount	Dimensions	Length	Art. No.	PU.
1/4" hexagon	4; 6; 8; 10	25 mm	<b>0614 250 302</b>	1

### **SPANNER, 70 MM**



Image in original size

E6.3 

Mount	Dimensions	Length	Art. No.	PU.
1/4" hexagon	6	70 mm	<b>0614 176 406</b>	5
1/4" hexagon	8	70 mm	<b>0614 176 408</b>	5

### **TRI-WING, 25 MM**

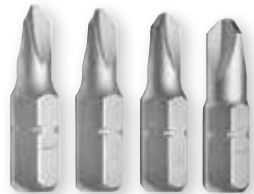

Image in original size

C6.3 

Mount	Size	Length	Art. No.	PU.
1/4" hexagon	1; 2; 3; 4	25 mm	<b>0614 250 303</b>	1

### **TRI-WING, 70 MM**



Image in original size

E6.3 

Mount	Dimensions	Length	Art. No.	PU.
1/4" hexagon	1	70 mm	<b>0614 176 301</b>	5
1/4" hexagon	2	70 mm	<b>0614 176 302</b>	5

### **TORQ, 25 MM**



Image in original size

C6.3 

Mount	Dimensions	Length	Art. No.	PU.
1/4" hexagon	6; 8; 10	25 mm	<b>0614 250 304</b>	1

### **HEXAGON SOCKET INCH, 25 MM**



Image in original size

C6.3 

Mount	Dimensions	Length	Art. No.	PU.
1/4" hexagon	1/8"; 9/64"; 5/32"; 3/16"	25 mm	<b>0614 250 306</b>	1



## SPECIAL AND SECURITY BITS

### **HEXAGON SOCKET WITH HOLE, 25 MM**



Image in original size

C6.3

Mount	Dimensions	Length	Art. No.	PU.
1/4" hexagon	2 x 3 (4) mm	25 mm	<b>0614 250 301</b>	1

### **SQUARE SOCKET, 25 MM**



Image in original size

C6.3

Mount	Dimensions	Length	Art. No.	PU.
1/4" hexagon	1; 2; 3; 4	25 mm	<b>0614 250 310</b>	1

### **CLUTCH, 25 MM**



Image in original size

C6.3

Mount	Dimensions	Length	Art. No.	PU.
1/4" hexagon	3/32"; 1/8"; 5/32"	25 mm	<b>0614 250 311</b>	1

### **FIVE STAR WITH HOLE, 70 MM**



Image in original size

E6.3

Mount	Dimensions	Length	Art. No.	PU.
1/4" hexagon	20	70 mm	<b>0614 176 420</b>	1
1/4" hexagon	25	70 mm	<b>0614 176 425</b>	1
1/4" hexagon	30	70 mm	<b>0614 176 430</b>	1

### **SCREW HOOK, 26 MM**



Image in original size

C6.3

Mount	Dimensions	Length	Art. No.	PU.
1/4" hexagon	-	26 mm	<b>0614 176 400</b>	1



# BIT ASSORTMENTS

## BIT BOX 1/4", 7 PIECES

- Impact-resistant plastic construction
- Clearly laid-out storage and easy removal

x with bit inserted



**Fits into any shirt pocket!**



Name	Quantity				Art. No.	PU.
Bitbox PH	2 x PH1	3 x PH2	1 x PH3	1 x bit holder, magnetic	<b>0614 250 12</b>	1
Bitbox PZ	2 x PZ1	3 x PZ2	1 x PZ3	1 x bit holder, magnetic	<b>0614 250 11</b>	1
Bit box AW® Mount	with AW®10	with AW®20	with AW®30	1 x bit holder, magnetic	<b>0614 250 16</b>	1

### ZEBRA® Bit, single



Design		Length	Art. No.	PU.
Bit 1/4"	PH1	25 mm	<b>0614 122 51</b>	10
Bit 1/4"	PH2	25 mm	<b>0614 122 52</b>	10
Bit 1/4"	PH3	25 mm	<b>0614 122 53</b>	10
Bit 1/4"	PZ1	25 mm	<b>0614 112 51</b>	10
Bit 1/4"	PZ2	25 mm	<b>0614 112 52</b>	10
Bit 1/4"	PZ3	25 mm	<b>0614 112 53</b>	10
Bit 1/4"	AW®10	25 mm	<b>0614 125 10</b>	10
Bit 1/4"	AW®20	25 mm	<b>0614 125 20</b>	10
Bit 1/4"	AW®25	25 mm	<b>0614 125 25</b>	10
Bit 1/4"	AW®30	25 mm	<b>0614 125 30</b>	10
Bit holder, magnetic	1/4" - E6.3	74 mm	<b>0614 176 688</b>	1
Bit holder, non-magnetic	1/4" - E6.3	74 mm	<b>0614 176 689</b>	1

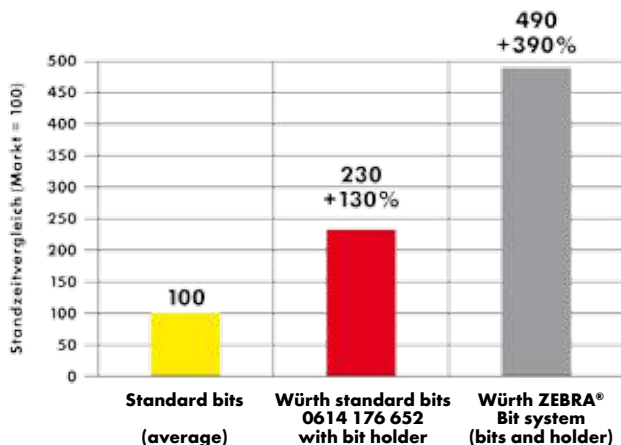

### ZEBRA® Bits hold for a long time

#### Experimental setup:

Mechanical screwing of Wüpfast® screws 5.0 x 60 (PZ2 Mount) into beech 60 mm deep.

## BIT ASSORTMENTS

### BIT BOX 1/4", 12 PIECES

- Bit box in high-quality, impact-resistant ABS plastic
- Fits perfectly into any shirt or trouser pocket
- Additional space for 1 bit holder
- Bit box dimensions (W x H x D): 86 x 53 x 20 mm



Clearly laid-out storage and easy removal



#### Alternative 1, Art. No. 0614 250 101

Design	Length	Art. No.	PU.
Bit 1/4" PZ1	25 mm	0614 176 651	4
Bit 1/4" PZ2	25 mm	0614 176 652	5
Bit 1/4" PZ3	25 mm	0614 176 653	3

#### Alternative 2, Art. No. 0614 250 102

Design	Length	Art. No.	PU.
Bit 1/4" AW <sup>®</sup> 10	25 mm	0614 511 0	3
Bit 1/4" AW <sup>®</sup> 20	25 mm	0614 512 0	5
Bit 1/4" AW <sup>®</sup> 30	25 mm	0614 513 0	3
Bit 1/4" AW <sup>®</sup> 40	25 mm	0614 514 0	1

#### Alternative 3, Art. No. 0614 250 103

Design	Length	Art. No.	PU.
Bit 1/4" PZ1	25 mm	0614 176 651	1
Bit 1/4" PZ2	25 mm	0614 176 652	2
Bit 1/4" PZ3	25 mm	0614 176 653	1
Bit 1/4" TX10	25 mm	0614 311 0	1
Bit 1/4" TX15	25 mm	0614 311 5	1
Bit 1/4" TX20	25 mm	0614 312 0	1
Bit 1/4" TX25	25 mm	0614 312 5	1
Bit 1/4" TX30	25 mm	0613 313 0	1
Bit 1/4" AW <sup>®</sup> 10	25 mm	0614 511 0	1
Bit 1/4" AW <sup>®</sup> 20	25 mm	0614 512 0	1
Bit 1/4" AW <sup>®</sup> 30	25 mm	0614 513 0	1

#### Alternative 4, Art. No. 0614 250 104

Design	Length	Art. No.	PU.
Bit 1/4" 0.8x5.5	25 mm	0614 175 653	1
Bit 1/4" PH1	25 mm	0614 176 274	1
Bit 1/4" PH2	25 mm	0614 176 461	1
Bit 1/4" PH3	25 mm	0614 176 648	1
Bit 1/4" PZ1	25 mm	0614 176 651	1
Bit 1/4" PZ2	25 mm	0614 176 652	1
Bit 1/4" TX10	25 mm	0614 311 0	1
Bit 1/4" TX20	25 mm	0614 312 0	1
Bit 1/4" TX25	25 mm	0614 312 5	1
Bit 1/4" TX30	25 mm	0614 313 0	1
Bit 1/4" SW4	25 mm	0614 176 94	1
Bit 1/4" SW5	25 mm	0614 176 95	1

### Suitable accessories

#### Bit box, empty

Dimensions (W x H x D):	Art. No.	PU.
86 x 53 x 20 mm	0614 250 100	1

## BIT BOX 1/4", 6 PIECES, 9 PIECES

- Impact-resistant plastic construction
- With impact-resistant plastic box
- Box precisely tailored to bits prevents them from falling out
- Length: 25 mm bits
- Additional space for 1 bit holder
- Dimensions (W x H): 50 x 20 mm



**Impact-resistant plastic construction**

Bit box	Length	Quantity						Art. No.	PU.
6 pieces	80 mm	1 x PH1	1 x PH2	1 x PH3	1 x PZ1	1 x PZ2	1 x PZ3	<b>0614 004*</b>	1
6 pieces	80 mm	1 x AW <sup>®</sup> 20	1 x AW <sup>®</sup> 25	AW <sup>®</sup> 30	1 x PH2	1 x PZ2	1 x PZ3	<b>0614 005*</b>	1
9 pieces	115 mm	3 x PH1	3 x PH2	3 x PH3				<b>0614 250 20</b>	1
9 pieces	115 mm	3 x PZ1	3 x PZ2	3 x PZ3				<b>0614 250 21</b>	1

\*Supplied incl. bit holder

## BIT BOX 1/4", AW<sup>®</sup>, 9 PIECES

- With impact-resistant plastic box.
- Length: 25 mm bits
- Additional space for 1 bit holder
- Dimensions (L x W x H): 115 x 50 x 20 mm



**Impact-resistant plastic construction**

Industry	Length	Quantity			Art. No.	PU.
Joiner	25 mm	3 x AW <sup>®</sup> 10	3 x AW <sup>®</sup> 20	3 x AW <sup>®</sup> 25	<b>0614 250 22</b>	1
	25 mm	2 x AW <sup>®</sup> 20	4 x AW <sup>®</sup> 25	3 x AW <sup>®</sup> 30	<b>0614 250 23</b>	1
Carpenter	25 mm	2 x AW <sup>®</sup> 10	5 x AW <sup>®</sup> 20	2 x AW <sup>®</sup> 30	<b>0614 250 24</b>	1
	25 mm	3 x AW <sup>®</sup> 20	3 x AW <sup>®</sup> 30	3 x AW <sup>®</sup> 40	<b>0614 250 25</b>	1

### Suitable accessories

**Bit box, empty**

Bit box	Art. No.	PU.
6 pieces	<b>0614 6</b>	1
9 pieces	<b>0614 9</b>	1

## BIT ASSORTMENTS

### BIT BOX 1/4", 10 PIECES

11 pieces. Assortment with all conventional bits in practical and robust plastic box.

- Impact-resistant plastic construction
- Including magnet holder 1/4"
- With impact-resistant plastic box
- Box precisely tailored to bits prevents them from falling out
- Self-adjusting automatic holder
- Length: 25 mm bits
- Dimensions (L x W x H): 132 x 69 x 18 mm



Usable as handheld screwMountr.

Bit box	Quantity					Art. No.	PU.
10 pieces	PH2	PH3	PZ3	SZ 0.8 x 5.5	TX20	<b>0614 250 40</b>	1
	TX25	TX30	TX40	2 x PZ2			
10 pieces	4 x AW <sup>®</sup> 20	AW <sup>®</sup> 25	3 x AW <sup>®</sup> 30	2 x AW <sup>®</sup> 40		<b>0614 250 41</b>	1

### Suitable accessories

#### Magnet holder 1/4"



Mount	Width	Length	Mount length	Art. No.	PU.
1/4"	14 mm	67 mm	27 mm	<b>0614 811 320</b>	1

### BIT SET 1/4", 17 PIECES

17 pieces. Practical bit set with all conventional bits.

- 16 bits: Length 25 mm, 1/4 inch mount
- 1 universal bit holder



Bit box	Quantity						Art. No.	PU.	
16 pieces	0.8 x 5.5	PZ1	PZ2	PZ3	PH1	PH2	4 mm hexagon	<b>0614 203</b>	1
	TX15	TX25	TX30	AW <sup>®</sup> 10	AW <sup>®</sup> 20	AW <sup>®</sup> 25	5 mm hexagon		

## BIT CASE 1/4", 36 PIECES

- Sturdy metal box
- Length: 25 mm bits



### Alternative 1, Art. No. 0614 250 1

Drive	Dimensions	Quantity
+	PH1	12
	PH2	18
	PH3	6

### Alternative 2, Art. No. 0614 250 2

Drive	Dimensions	Quantity
*	PZ1	12
	PZ2	18
	PZ3	6

### Alternative 3, Art. No. 0614 250 3

Drive	Dimensions	Quantity
⊖	AW <sup>®</sup> 10	12
	AW <sup>®</sup> 20	18
	AW <sup>®</sup> 30	6

### Alternative 4, Art. No. 0614 250 31

Drive	Dimensions	Quantity
⊖	AW <sup>®</sup> 20	18
	AW <sup>®</sup> 30	18

### Alternative 5, Art. No. 0614 250 5

Drive	Dimensions	Quantity
+	PH1	6
	PH2	6
	PH3	6
*	PZ1	6
	PZ2	6
	PZ3	6

### Alternative 6, Art. No. 0614 250 6

Drive	Dimensions	Quantity
+	PH1	6
	PH2	12
	PH3	6
-	0.5x3.0	2
	0.6x4.5	2
	0.8x5.5	2
	1.0x6.0	2
	1.2x6.5	2
	1.2x8.0	2

### Alternative 7, Art. No. 0614 250 7

Drive	Dimensions	Quantity
+	PH1	6
	PH2	6
	PH3	6
-	0.5x3.0	1
	0.6x4.5	1
	0.8x5.5	1
	1.0x6.0	1
	1.2x6.5	1
	1.2x8.0	1
⊖	SW3	1
	SW4	2
	SW5	2
	SW6	1
*	TX10	1
	TX15	1
	TX20	1
	TX25	1
	TX30	1
	TX40	1

### Alternative 8, Art. No. 0614 250 8

Drive	Dimensions	Quantity
*	PZ1	6
	PZ2	12
	PZ3	6
-	0.5x3.0	1
	0.6x4.5	1
	0.8x5.5	1
	1.0x6.0	1
	1.2x6.5	1
	1.2x8.0	1
+	TX10	1
	TX15	1
	TX20	1
	TX25	1
	TX30	1
	TX40	1

### Alternative 9, Art. No. 0614 250 10

Drive	Dimensions	Quantity
*	TX9	3
	TX10	6
	TX15	3
	TX20	6
	TX25	6
	TX27	3
	TX30	6
	TX40	3

## BIT ASSORTMENTS

### SECURITY BIT CASE, 1/4", 30 PIECES

**Art. No. 0614 250 30**

This set contains all major bits required for installing and removing security screws.

**Contents: 29 pieces**

- 1x bit with bore: C 6.3 (1/4 in) TX 8, 9, 10, 15, 20, 25, 27, 30, 40
- 1x hexagon socket bit with bore: C 6.3 (1/4 in) sizes 2, 2.5, 3, 4, 5, 6
- 1x spanner bit: C 6.3 (1/4 in) sizes 4, 6, 8, 10
- 1x tri-wing bit C 6.3 (1/4 in) sizes 1, 2, 3, 4
- 1x torque bit C 6.3 (1/4 in) sizes 6, 8, 10
- 1x screwdriver with quick-change chuck
- 2x adapters 1/4 in

- Sturdy metal box
- Set contains all major bits required for installing and removing security screws



Name	Mount	Drive	Art. No.	PU.
1 screw with quick-change chuck and 1/4" bit holder	-		<b>0613 210 21</b>	1
Adapter for 1/4" hexagon bits			<b>0614 176 680</b>	1
Adapter for 1/4" square mount			<b>0614 176 700</b>	1
TX bit with hole		TX8	<b>0614 352 608</b>	1
		TX9	<b>0614 352 609</b>	1
		TX10	<b>0614 352 610</b>	1
		TX15	<b>0614 352 615</b>	1
		TX20	<b>0614 352 620</b>	1
		TX25	<b>0614 352 625</b>	1
		TX27	<b>0614 352 627</b>	1
		TX30	<b>0614 352 630</b>	1
		TX40	<b>0614 352 640</b>	1
		Hexagon socket with hole bit set, 6 pieces		2; 2.5; 3; 4; 5; 6
Spanner bit set, 4 pieces		4; 6; 8; 10	<b>0614 250 302</b>	1
Tri-wing bit set, 4 pieces		1; 2; 3; 4	<b>0614 250 303</b>	1
Torque bit set, 3 pieces		6; 8; 10	<b>0614 250 304</b>	1



## BIT ASSORTMENTS



**Security screws are used wherever unauthorized removal is to be prevented, e.g.:**

- Electrical and electronics sector
- Power tools
- Automotive and motorcycle sector
- Public facilities

These screws can be removed using security bits.

## BIT CASE WITH STANDARD AND SECURITY BITS 1/4", 105 PIECES



















**Art. No. 0614 250 300**

- The solution for almost any screw application
- Supplied incl. two bit adapters and one screw hook
- Areas of application: Public facilities, automotive and motorcycle sector, sanitary facilities, construction industry, electrical and electronics sector, machining sector



Drive	Dimensions	Length	Art. No.	Quantity
⊕	AW <sup>®</sup> 10	25 mm	<b>0614 511 0</b>	1
	AW <sup>®</sup> 20	25 mm	<b>0614 512 0</b>	2
	AW <sup>®</sup> 25	25 mm	<b>0614 512 5</b>	1
	AW <sup>®</sup> 30	25 mm	<b>0614 513 0</b>	1
	AW <sup>®</sup> 40	25 mm	<b>0614 514 0</b>	1
⊖	0.6 x 4.5 mm	25 mm	<b>0614 175 652</b>	1
	0.8 x 5.5 mm	25 mm	<b>0614 175 653</b>	1
	1.2 x 6.5 mm	25 mm	<b>0614 175 655</b>	1
	1.2 x 8.0 mm	25 mm	<b>0614 175 656</b>	1
+	PH0	25 mm	<b>0614 176 270</b>	1
	PH1	25 mm	<b>0614 176 274</b>	2
	PH2	25 mm	<b>0614 176 461</b>	3
	PH3	25 mm	<b>0614 176 648</b>	1
⊗	PZ0	25 mm	<b>0614 176 640</b>	1
	PZ1	25 mm	<b>0614 176 651</b>	2
	PZ2	25 mm	<b>0614 176 652</b>	3
⊗	PZ3	25 mm	<b>0614 176 653</b>	1
	TX8	25 mm	<b>0614 310 8</b>	1
	TX10	25 mm	<b>0614 311 0</b>	1
⊕	TX15	25 mm	<b>0614 311 5</b>	1
	TX20	25 mm	<b>0614 312 0</b>	1
	TX25	25 mm	<b>0614 312 5</b>	1
	TX27	25 mm	<b>0614 312 7</b>	1
	TX30	25 mm	<b>0614 313 0</b>	1
	TX40	25 mm	<b>0614 314 0</b>	1
	TX45	25 mm	<b>0614 314 51</b>	1
⊕	2 mm hexagon socket	25 mm	<b>0614 176 92</b>	1
	2.5 mm hexagon socket	25 mm	<b>0614 176 925</b>	1
	3 mm hexagon socket	25 mm	<b>0614 176 93</b>	1
	4 mm hexagon socket	25 mm	<b>0614 176 94</b>	1
	5 mm hexagon socket	25 mm	<b>0614 176 95</b>	1
	6 mm hexagon socket	25 mm	<b>0614 176 96</b>	1
	1/4" hexagon socket	25 mm	<b>0614 176 963</b>	1
7 mm hexagon socket	25 mm	<b>0614 176 97</b>	1	

## BIT ASSORTMENTS

	Drive	Length	Art. No.	Quantity
	TX8 with hole	25 mm	<b>0614 352 608</b>	1
	TX10 with hole	25 mm	<b>0614 352 610</b>	1
	TX15 with hole	25 mm	<b>0614 352 615</b>	1
	TX20 with hole	25 mm	<b>0614 352 620</b>	1
	TX25 with hole	25 mm	<b>0614 352 625</b>	1
	TX27 with hole	25 mm	<b>0614 352 627</b>	1
	TX30 with hole	25 mm	<b>0614 352 630</b>	1
	TX40 with hole	25 mm	<b>0614 352 640</b>	1
	TX45 with hole	25 mm	<b>0614 352 645</b>	1
	4; 6; 8; 10 spanner	25 mm	<b>0614 250 302</b>	4
	1; 2; 3; 4 tri-wing	25 mm	<b>0614 250 303</b>	4
	6; 8; 10 Torque	25 mm	<b>0614 250 304</b>	3
	M4; M5; M6; M8 polydrive	25 mm	<b>0614 250 305</b>	4
	1/8"; 3/16"; 1/4"; 3/8" inch hexagon socket	25 mm	<b>0614 250 306</b>	4
	M5; M6; M7; M8 wedge shape	25 mm	<b>0614 250 307</b>	4
	2 mm; 2,5 mm; 3 mm; 4 mm; 5 mm; 6 mm; 7 mm hexagon with hole	25 mm	<b>0614 250 301</b>	7
	1; 2; 3; 4 square	25 mm	<b>0614 250 310</b>	4
	3/32"; 1/8"; 5/32" clutch	25 mm	<b>0614 250 311</b>	3
	0.8 x 5 mm slotted	70 mm	<b>0614 175 662</b>	1
	PH1	70 mm	<b>0614 176 774</b>	1
	PH2	70 mm	<b>0614 176 775</b>	1
	1 tri-wing	70 mm	<b>0614 176 301</b>	1
	2 tri-wing	70 mm	<b>0614 176 302</b>	1
	6 spanner	70 mm	<b>0614 176 406</b>	1
	8 spanner	70 mm	<b>0614 176 408</b>	1
	TX10 with hole	70 mm	<b>0614 371 0</b>	1
	TX15 with hole	70 mm	<b>0614 371 5</b>	1
	TX20 with hole	70 mm	<b>0614 372 0</b>	1
	TX25 with hole	70 mm	<b>0614 372 5</b>	1
	TX30 with hole	70 mm	<b>0614 373 0</b>	1
	Five star with hole 20	70 mm	<b>0614 176 420</b>	1
	Five star with hole 25	70 mm	<b>0614 176 425</b>	1
	Five star with hole 30	70 mm	<b>0614 176 430</b>	1
	Screw hook	26 mm	<b>0614 176 400</b>	1
	1/4" bit adapter	30 mm	<b>0614 176 680</b>	1
	1/4" magnetic bit holder	70 mm	<b>0614 176 702</b>	1

## BIT ASSORTMENTS

### BIT CASE 1/4", 10 PIECES



- **Mount:** 1/4 inch
- **Number of pieces in assortment/set:** 10 PCS

**Art. No. 0614 250 010**

**For hard-to-reach areas** 70 mm long bits

**Quick and easy to replace** Practical belt clip

**Easy to choose the right bit** Colour guide system

Content of assortment	Art. No.
0614 250 010 AW® 10 bit	<b>0614 571 0</b>
AW® 20 bit	<b>0614 572 0</b>
AW® 30 bit	<b>0614 573 0</b>
PH1 Phillips bit	<b>0614 176 774</b>
PH2 Phillips bit	<b>0614 176 775</b>
PZ1 Pozidriv bit	<b>0614 176 776</b>
PZ2 Pozidriv bit	<b>0614 176 777</b>
TX20 bit	<b>0614 332 0</b>
TX25 bit	<b>0614 332 5</b>
TX30 bit	<b>0614 333 0</b>

### BIT CASE, 12 PIECES



12 pieces With 10 different 1/4 inch bits, a mini bit ratchet, a magnetic bit holder and practical belt clip.

**Art. No. 0614 250 013**

- Easy removal and clearly arranged bit storage thanks to clamping strip and stamped profile designation
- Ratchet
- Bit holder
- Practical storage
- Colour-coding system

- **Number of pieces in assortment/set:** 12 PCS
- **Length:** 170 mm
- **Width:** 90 mm
- **Height:** 30 mm

Assortment content	Art. No.
0614 250 013 AW® bit	<b>0614 511 0</b>
AW® bit	<b>0614 512 0</b>
AW® bit	<b>0614 513 0</b>
Phillips bit	<b>0614 176 274</b>
Phillips bit	<b>0614 176 461</b>
Pozidriv bit	<b>0614 176 652</b>
Slotted bit	<b>0614 175 653</b>
TX bit	<b>0614 311 5</b>
TX bit	<b>0614 312 0</b>
TX bit	<b>0614 312 5</b>

## BIT ASSORTMENTS

### BIT BOX STAINLESS STEEL C6.3 1/4" 10 PIECES

**Art. No. 0614 250 510**

10 pieces With 8 different 1/4 inch bits and a stainless steel quick-change holder.



**No extraneous rust**

The bits are made from stainless steel and are vacuum ice-hardened.

**Quick bit change**

High-quality 1/4 inch torsion bits with stainless steel quick-change holder

**Easy bit removal**

Bit box with tilt function

**Includes:**

- 1 x TX 10/TX 15/TX 20/TX 25/TX 30
- 1 x PZ 1/2x PZ 2/1x PH 2
- 1 x bit holder 50 mm

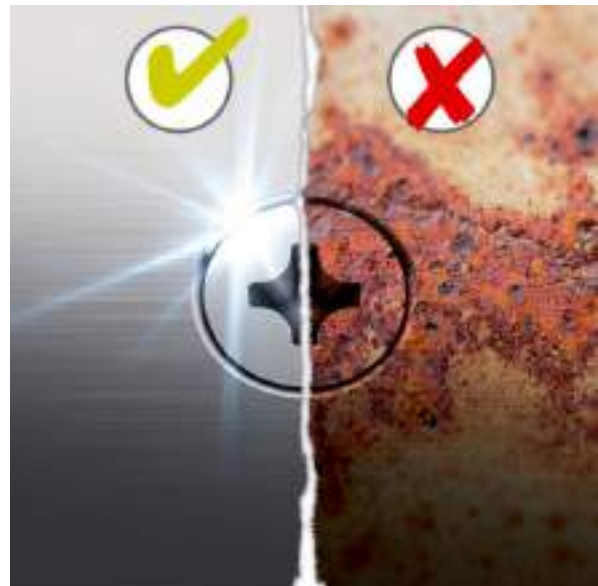

## BIT CASE 1/4", 59 PIECES

**Art. No. 0614 250 59**

- 36 short bits, 15 long bits, 2 magnetic bit holders, 1 adapter, 5 socket wrench bits
- Color code
- Easy to remove and clear storage of bits
- Includes magnetic socket wrench bits
- **Mount 1/4 inch**
- **Number of pieces in assortment/set: 59**

Assortment content	Art. No.
0614 250 59	1/4 inch socket wrench insert, set
	<b>0614 176 01</b>
	AW® 10 bit; 25 mm
	<b>0614 511 0</b>
	3 x AW® 20 bit; 25 mm
	<b>0614 512 0</b>
	AW® 25 bit; 25 mm
	<b>0614 512 5</b>
	AW® 30 bit; 25 mm
	<b>0614 513 0</b>
	AW® 40 bit; 25 mm
	<b>0614 514 0</b>
	AW® 10 bit; 70 mm
	<b>0614 571 0</b>
	AW® 20 bit; 70 mm
	<b>0614 572 0</b>
	AW® 30 bit; 70 mm
	<b>0614 573 0</b>
	Connector DIN 7427 1/4 inch
	<b>0614 176 680</b>
	2 mm hexagon socket bit; 25 mm
	<b>0614 176 92</b>
	2.5 mm hexagon socket bit; 25 mm
	<b>0614 176 925</b>
	3 mm hexagon socket bit; 25 mm
	<b>0614 176 93</b>
	4 mm hexagon socket bit; 25 mm
	<b>0614 176 94</b>
	5 mm hexagon socket bit; 25 mm
	<b>0614 176 95</b>
	6 mm hexagon socket bit; 25 mm
	<b>0614 176 96</b>
	PH0 Phillips bit; 25 mm; 25 mm
	<b>0614 176 270</b>
	PH1 Phillips bit; 25 mm; 25 mm
	<b>0614 176 274</b>
	3 x PH2 Phillips bit; 25 mm; 25 mm
	<b>0614 176 461</b>
	PH3 Phillips bit; 25 mm; 25 mm
	<b>0614 176 648</b>
	PH1 Phillips bit; 73 mm; 73 mm
	<b>0614 176 774</b>
	PH2 Phillips bit; 73 mm; 73 mm
	<b>0614 176 775</b>
	PZ0 Pozidriv bit; 25 mm; 25 mm
	<b>0614 176 640</b>
	PZ1 Pozidriv bit; 25 mm; 25 mm
	<b>0614 176 651</b>
	3 x PZ2 Pozidriv bit; 25 mm; 25 mm
	<b>0614 176 652</b>
	PZ3 Pozidriv bit; 25 mm; 25 mm
	<b>0614 176 653</b>
	PZ1 Pozidriv bit; 73 mm; 73 mm
	<b>0614 176 776</b>
	PZ2 Pozidriv bit; 73 mm; 73 mm
	<b>0614 176 777</b>
	0.6 x 4.5 mm slotted bit; 25 mm
	<b>0614 175 652</b>
	0.8 x 5.5 mm slotted bit; 25 mm
	<b>0614 175 653</b>

Assortment content	Art. No.
0614 250 59	1.2 x 8.0 mm slotted bit; 25 mm
	<b>0614 175 656</b>
	0.8 x 4.0 mm slotted bit; 73 mm
	<b>0614 175 661</b>
	1.0 x 6.0 mm slotted bit; 73 mm
	<b>0614 175 663</b>
	TX10 bit; 25 mm
	<b>0614 311 0</b>
	TX15 bit; 25 mm
	<b>0614 311 5</b>
	2 x TX20 bit 0; 25 mm
	<b>0614 312 0</b>
	TX25 bit; 25 mm
	<b>0614 312 5</b>
	TX27 bit; 25 mm
	<b>0614 312 7</b>
	TX30 bit; 25 mm
	<b>0614 313 0</b>
	TX40 bit; 25 mm
	<b>0614 314 0</b>
	TX10 bit; 70 mm
	<b>0614 331 0</b>
	TX15 bit; 70 mm
	<b>0614 331 5</b>
	TX20 bit; 70 mm
	<b>0614 332 0</b>
	TX25 bit; 70 mm
	<b>0614 332 5</b>
	TX27 bit; 70 mm
	<b>0614 332 7</b>
	TX30 bit; 70 mm
	<b>0614 333 0</b>
	E 6.3 (1/4") universal holder; 74 mm
	<b>0614 176 702</b>
	E 6.3 (1/4") universal holder; 175 mm
	<b>0614 176 758</b>

## BIT CASE TX WITH HOLE, 14 PIECES

**Art. No. 0614 250 353**

- Sturdy metal box
- Metal box with screwMountr and 3 adapters



For TX profile with pin

Name	Mount	Drive	Art. No.	PU.
1 screwMountr with quick-change chuck and 1/4" bit holder	-	1/4"	<b>0613 210 21</b>	1
Adapter	1/4"	1/4"	<b>0614 176 680</b>	1
		5/16"	<b>0695 177 982</b>	1
	1/2"	5/16"	<b>0614 215 010</b>	1
TX bit with inside hole	1/4" 26 mm	TX10	<b>0614 352 610</b>	1
		TX15	<b>0614 352 615</b>	1
		TX20	<b>0614 352 620</b>	1
		TX25	<b>0614 352 625</b>	1
		TX27	<b>0614 352 627</b>	1
		TX30	<b>0614 352 630</b>	1
	5/16" 35 mm	TX40	<b>0614 352 640</b>	1
		TX45	<b>0614 353 545</b>	1
		TX50	<b>0614 353 550</b>	1
		TX55	<b>0614 353 555</b>	1
		Metal box, empty, size 1	-	-
Foam insert, empty	-	-	<b>0955 250 353</b>	1

## BIT BOX TX WITH HOLE, 6 PIECES

**Art. No. 0614 250 352**

- Impact-resistant plastic construction



Name	Mount	Drive	Art. No.	PU.
TX bit with inside hole	1/4" 26 mm	TX10	<b>0614 352 610</b>	1
		TX15	<b>0614 352 615</b>	1
		TX20	<b>0614 352 620</b>	1
		TX25	<b>0614 352 625</b>	1
		TX30	<b>0614 352 630</b>	1
		TX40	<b>0614 352 640</b>	1

## BIT ASSORTMENTS

### BIT CASE WITH BITS WITH HOLE, 8 PIECES



The bit box is always easily accessible thanks to the belt clip.

One-hand operation: Remove the bit box from the holder, pull down the red button, the bit box swivels open and bits can be removed directly with the magnetic bit holder.

Art. No. 0614 250 115

#### Easy and quick removal and replacement of bits

- 180° swiveling mechanism enables bits to be removed with one hand.
- Can be removed directly with the machine mount.

#### Rugged

The bit box is made of impact-resistant reinforced plastic.

#### Space-saving and easily accessible thanks to the belt clip feature

#### Includes integrated universal bit holder with magnet

- **Mount:** 1/4 inch
- **Number of pieces in assortment/set:** 8 PCS



Designation	Drive	Mount	Length in mm	Art. No.	Quantity	
PH2	+	1/4" hexagon	29	0614 176 462	1	
PZ2	*			0614 176 642		
TX20	⊕			0614 312 03	2	
TX25				0614 312 51		
TX30				0614 313 03	1	
TX40				0614 314 03		
Universal Holder	⊙			1/4" E6.3	0614 176 754	

#### Especially suitable

- For use with high-performance tangential impact screwdrivers.
- For extremely high load applications (e.g. in hard wood, metal, sheet metal etc.).

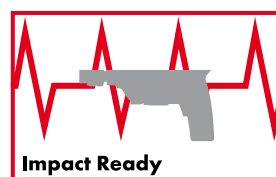

## BIT CASE WITH RATCHET 10 MM, 38 PIECES

**Art. No. 0965 12 370**

- Sturdy metal box
- Special bit assortment for motor vehicle and cargo applications



Including bit ratchet for 10 mm bits



Bit ratchet also available individually!

**Art. No. 0714 12 100**

- Head: 72 teeth, 5° angle of rotation, round, compact head
- Base body: chrome-plated, non-slip 2-component handle

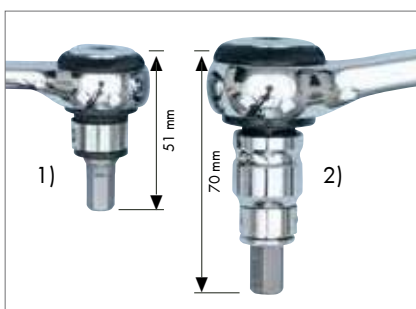

- 1) ratchet with short 10-mm bit
- 2) standard 1/2" ratchet with adapter

Name	Drive	Length	Art. No.	Quantity
Ratchet for 10 mm bits		175 mm	<b>0714 12 100</b>	1
Adapter for 1/2" ratchet tool		37 mm	<b>0715 13 03</b>	1
TX20		30 mm	<b>0614 788 20</b>	1/5
TX25		30 mm	<b>0614 788 25</b>	1/5
TX27		30 mm	<b>0614 788 27</b>	1/5
TX30		30 mm	<b>0614 788 30</b>	1/5
TX40		30 mm	<b>0614 788 40</b>	1/5
TX45		30 mm	<b>0614 788 45</b>	1/5
TX50		30 mm	<b>0614 788 50</b>	1/5
TX55		30 mm	<b>0614 788 55</b>	1/5
TX20		75 mm	<b>0614 788 120</b>	1/5
TX25		75 mm	<b>0614 788 125</b>	1/5
TX27		75 mm	<b>0614 788 127</b>	1/5
TX30		75 mm	<b>0614 788 130</b>	1/5
TX40		75 mm	<b>0614 788 140</b>	1/5
TX45		75 mm	<b>0614 788 145</b>	1/5
TX50		75 mm	<b>0614 788 150</b>	1/5
TX55		75 mm	<b>0614 788 155</b>	1/5
TX40		120 mm	<b>0614 788 240</b>	1/5
TX45		120 mm	<b>0614 788 245</b>	1/5
TX50		120 mm	<b>0614 788 250</b>	1/5
Hexagon socket SW5		30 mm	<b>0614 788 305</b>	1/5
Hexagon socket SW6		30 mm	<b>0614 788 306</b>	1/5
Hexagon socket SW7		30 mm	<b>0614 788 307</b>	1/5
Hexagon socket SW8		30 mm	<b>0614 788 308</b>	1/5
Hexagon socket SW10		30 mm	<b>0614 788 310</b>	1/5
Hexagon socket SW12		30 mm	<b>0614 788 312</b>	1/5
XZN M5		30 mm	<b>0614 788 405</b>	1/5
XZN M6		30 mm	<b>0614 788 406</b>	1/5
XZN M8		30 mm	<b>0614 788 408</b>	1/5
XZN M10		30 mm	<b>0614 788 410</b>	1/5
XZN M12		30 mm	<b>0614 788 412</b>	1/5
XZN M6			75 mm	<b>0614 788 506</b>
XZN M8	75 mm		<b>0614 788 508</b>	1/5
XZN M10	75 mm		<b>0614 788 510</b>	1/5
XZN M12	75 mm		<b>0614 788 512</b>	1/5
PH2			30 mm	<b>0614 788 902</b>
PH3		30 mm	<b>0614 788 903</b>	1/5
Foam insert 270 x 155 x 35 mm			<b>0955 12 370</b>	1
Metal box, size 5 280 x 165 x 45 mm			<b>0955 12 371</b>	1







## BIT ASSORTMENTS





# BIT CASE WITH SOCKET WRENCH, 10 MM, 47 PIECES

Art. No. 0965 12 470

- Sturdy metal box
- Assortment with the most common 10-mm bits for the automotive and cargo sectors



Name	Drive	Length	Art. No.	PU.	
Adapter for 3/8" ratchet tool		29 mm	<b>0715 12 02</b>	1	
Adapter for 1/2" ratchet tool		37 mm	<b>0715 13 03</b>	1	
TX20		30 mm	<b>0614 788 20</b>	1	
TX25		30 mm	<b>0614 788 25</b>	1	
TX27		30 mm	<b>0614 788 27</b>	1	
TX30		30 mm	<b>0614 788 30</b>	1	
TX40		30 mm	<b>0614 788 40</b>	1	
TX45		30 mm	<b>0614 788 45</b>	1	
TX50		30 mm	<b>0614 788 50</b>	1	
TX55		30 mm	<b>0614 788 55</b>	1	
TX20			75 mm	<b>0614 788 120</b>	1
TX25			75 mm	<b>0614 788 125</b>	1
TX27	75 mm		<b>0614 788 127</b>	1	
TX30	75 mm		<b>0614 788 130</b>	1	
TX40	75 mm		<b>0614 788 140</b>	1	
TX45	75 mm		<b>0614 788 145</b>	1	
TX50	75 mm		<b>0614 788 150</b>	1	
TX55	75 mm		<b>0614 788 155</b>	1	
Hexagon socket SW5			30 mm	<b>0614 788 305</b>	1
Hexagon socket SW6			30 mm	<b>0614 788 306</b>	1
Hexagon socket SW7		30 mm	<b>0614 788 307</b>	1	
Hexagon socket SW8		30 mm	<b>0614 788 308</b>	1	
Hexagon socket SW10		30 mm	<b>0614 788 310</b>	1	





Designation	Drive	Length	Art. No.	PU.	
Polydrive M5		30 mm	<b>0614 788 405</b>	1	
Polydrive M6		30 mm	<b>0614 788 406</b>	1	
Polydrive M8		30 mm	<b>0614 788 408</b>	1	
Polydrive M10		30 mm	<b>0614 788 410</b>	1	
Polydrive M12		30 mm	<b>0614 788 412</b>	1	
Polydrive M6		75 mm	<b>0614 788 506</b>	1	
Polydrive M8		75 mm	<b>0614 788 508</b>	1	
Polydrive M10		75 mm	<b>0614 788 510</b>	1	
Polydrive M12		75 mm	<b>0614 788 512</b>	1	
Wedge shape R15		30 mm	<b>0614 788 605</b>	1	
Wedge shape R16		30 mm	<b>0614 788 606</b>	1	
Wedge shape R17		30 mm	<b>0614 788 607</b>	1	
Wedge shape R18		30 mm	<b>0614 788 608</b>	1	
Wedge shape R19		30 mm	<b>0614 788 609</b>	1	
Wedge shape R110		30 mm	<b>0614 788 610</b>	1	
Wedge shape R112		30 mm	<b>0614 788 612</b>	1	
Wedge shape R113		30 mm	<b>0614 788 613</b>	1	
Wedge shape R114		30 mm	<b>0614 788 614</b>	1	
Wedge shape R15			75 mm	<b>0614 788 705</b>	1
Wedge shape R16			75 mm	<b>0614 788 706</b>	1
Wedge shape R18			75 mm	<b>0614 788 708</b>	1
Wedge shape R110			75 mm	<b>0614 788 710</b>	1
PH2				30 mm	<b>0614 788 902</b>
PH3	30 mm	<b>0614 788 903**</b>		1	
Foam insert 270 x 155 x 35 mm	-		<b>0955 12 470</b>	1	
Metal box, size 5 280 x 165 x 45 mm	-		<b>0955 12 371</b>	1	

## BIT CASE WITH SOCKET WRENCH, 10 MM, 30 PIECES

**Art. No. 0965 12 300**

- Sturdy metal box
- Complete assortment with TX head socket wrench and bits.



Name	Drive	Length	Art. No.	PU.
TX20		30 mm	<b>0614 788 20</b>	1
TX25		30 mm	<b>0614 788 25</b>	1
TX27		30 mm	<b>0614 788 27</b>	1
TX30		30 mm	<b>0614 788 30</b>	1
TX40		30 mm	<b>0614 788 40</b>	1
TX45		30 mm	<b>0614 788 45</b>	1
TX50		30 mm	<b>0614 788 50</b>	1
TX55		30 mm	<b>0614 788 55</b>	1
TX20		75 mm	<b>0614 788 120</b>	1
TX25		75 mm	<b>0614 788 125</b>	1
TX27		75 mm	<b>0614 788 127</b>	1
TX30		75 mm	<b>0614 788 130</b>	1
TX40		75 mm	<b>0614 788 140</b>	1
TX45		75 mm	<b>0614 788 145</b>	1
TX50		75 mm	<b>0614 788 150</b>	1
TX55		75 mm	<b>0614 788 155</b>	1
¼" socket wrench E 5		22 mm	<b>0715 112 05</b>	1
¼" socket wrench E 6		22 mm	<b>0715 112 06</b>	1
¼" socket wrench E 7		22 mm	<b>0715 112 07</b>	1
¼" socket wrench E 8		22 mm	<b>0715 112 08</b>	1
¼" socket wrench E 10		22 mm	<b>0715 112 10</b>	1
½" socket wrench E 11		40 mm	<b>0715 132 11</b>	1
½" socket wrench E 12		40 mm	<b>0715 132 12</b>	1
½" socket wrench E 14		40 mm	<b>0715 132 14</b>	1
½" socket wrench E 16		40 mm	<b>0715 132 16</b>	1
½" socket wrench E 18		40 mm	<b>0715 132 18</b>	1
½" socket wrench E 20		40 mm	<b>0715 132 20</b>	1
½" socket wrench E 24		40 mm	<b>0715 132 24</b>	1
Adapter for ⅜" ratchet tool			29 mm	<b>0715 12 02</b>
Adapter for ½" ratchet tool	37 mm		<b>0715 13 03</b>	1
Foam insert 270 x 155 x 35 mm			<b>0955 12 300</b>	1
Metal box, size 5 280 x 165 x 45 mm			<b>0955 12 371</b>	1

## BIT ASSORTMENTS

# BIT CASE WITH RATCHET SPANNER, 10 MM AND 1/4", 32 PIECES

Art. No. 0714 23 100

- Sturdy metal box
- Special tool assortment for tight spaces.

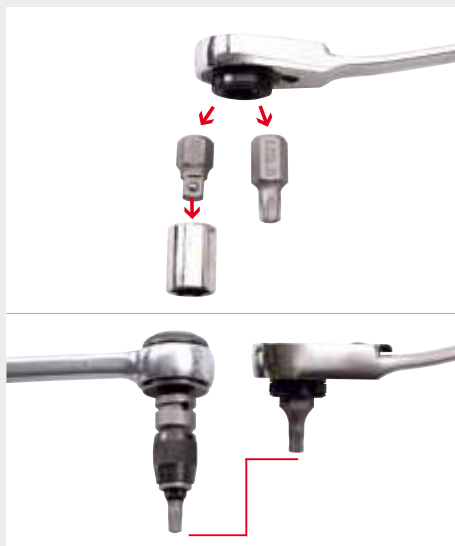

### Application:

- Can be used with bits and socket spanners.
- Double function of special ratchet with 1/4" and 10 mm mount
- Low overall height of the special ratchet
- compared to standard 1/4" ratchets

Name	Drive	Length	Art. No.	Quantity
Double ring ratchet wrench 1/4" - 10 mm		200 mm	<b>0714 23 101</b>	1
Double ring ratchet wrench 1/4" - 10 mm		110 mm	<b>0714 23 102</b>	1
Adapter 1/4" - 10 mm		22 mm	<b>0715 11 02</b>	1
1/4" bits:				
<b>TX15</b>		25 mm	<b>0614 311 5</b>	1
TX20		25 mm	<b>0614 312 0</b>	1
<b>TX25</b>		25 mm	<b>0614 312 5</b>	1
TX27		25 mm	<b>0614 312 7</b>	1
Slotted 5.5 mm		25 mm	<b>0614 175 653</b>	1
Slotted 8.0 mm		25 mm	<b>0614 175 656</b>	1
Hexagon socket SW 4 mm		25 mm	<b>0614 176 94</b>	1
Hexagon socket SW 5 mm		25 mm	<b>0614 176 95</b>	1
Hexagon socket SW 6 mm		25 mm	<b>0614 176 96</b>	1
<b>PH1</b>		25 mm	<b>0614 176 274</b>	1
PH2		25 mm	<b>0614 176 461</b>	1
<b>PH3</b>		25 mm	<b>0614 176 648</b>	1
10 mm bits				
TX30		30 mm	<b>0614 788 830</b>	1
TX40		30 mm	<b>0614 788 840</b>	1
TX45		30 mm	<b>0614 788 845</b>	1
XZN M5		30 mm	<b>0614 788 405</b>	1
XZN M6		30 mm	<b>0614 788 406</b>	1
XZN M8		30 mm	<b>0614 788 408</b>	1
Hexagon socket SW 7 mm		30 mm	<b>0614 788 307</b>	1
Hexagon socket SW 8 mm		30 mm	<b>0614 788 308</b>	1
1/4" hexagon wrench inserts				
SW 6 mm		22 mm	<b>0713 111 106</b>	1
SW 7 mm		22 mm	<b>0713 111 107</b>	1
SW 8 mm		22 mm	<b>0713 111 108</b>	1
SW 9 mm		22 mm	<b>0713 111 109</b>	1
SW 10 mm		22 mm	<b>0713 111 110</b>	1
SW 11 mm		22 mm	<b>0713 111 111</b>	1
SW 12 mm		22 mm	<b>0713 111 112</b>	1
SW 13 mm		22 mm	<b>0713 111 113</b>	1
SW 14 mm		22 mm	<b>0713 111 114</b>	1
Foam insert 215 x 105 x 30 mm				<b>0955 23 100</b>
Metal box, size 1 220 x 110 x 35 mm			<b>0955 715 1</b>	1

## BIT ASSORTMENTS IN EVA FOAM

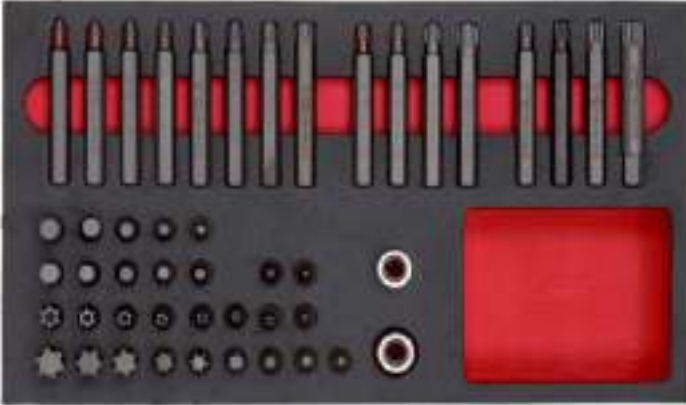

### Application Area:

For custom equipping of workshop trolleys, ORSY BULL boxes, vehicle interior equipment and ORSY shelving systems.

### Art. 0965 900 906

#### Bit Assortment, 47-pieces

Contents:

- Adapter for 3/8 inch ratchet, 29 mm, adapter for 1/2 inch ratchet, 37 mm
- TX bits with borehole, 30 mm: TX 20, 25, 27, 30, 40, 45, 50, 55
- TX bits without borehole, 75 mm: TX 20, 25, 27, 20, 40, 45, 50, 55
- Hexagon socket bit, 30 mm: Sizes 5, 6, 7, 8, 10
- XZN multipoint bit, 30 mm: M 5, 6, 8, 10, 12
- XZN multipoint bit, 75 mm: M 6, 8, 10, 12
- Bit wedge RI, 30 mm: RI 5, 6, 7, 8, 9, 10, 12, 13, 14
- RI wedge bit, 75 mm: RI 5, 6, 8, 10
- Recessed head bit, 30 mm: PH 2, PH 3
- Empty foam insert, size 2

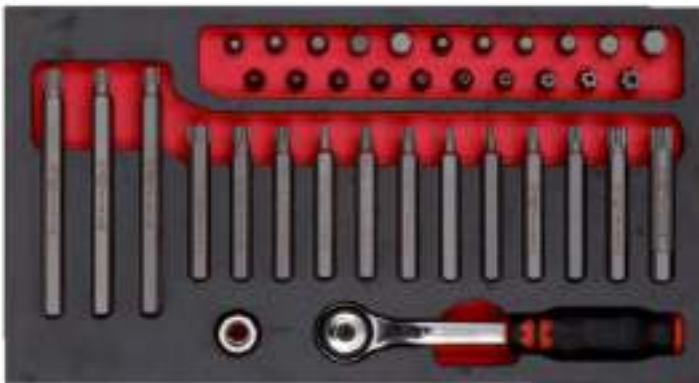

### Application Area:

For custom equipping of workshop trolleys, ORSY BULL boxes, vehicle interior equipment and ORSY shelving systems.

### Art. 0965 900 907

#### Ratchet bit assortment, 10mm, 38pc

Contents:

- Ratchet tool 10 mm, 10 mm bits
- Adapter for 1/2 inch ratchet tool, 37 mm
- TX bits with borehole, 30 mm: TX 20, 25, 27, 30, 40, 45, 50, 55
- TX bits without borehole, 75 mm: TX 20, 25, 27, 30, 40, 45, 50, 55
- TX bits without borehole, 120 mm: TX 40, 45, 50
- Hexagon socket bit, 30 mm: Sizes 5, 6, 7, 8, 10, 12
- XZN multipoint bit, 30 mm: M 5, 6, 8, 10, 12
- XZN multipoint bit, 75 mm: M 6, 8, 10, 12
- Recessed head bit, 30 mm: PH 2, PH 3
- Empty foam insert, size 2



**BIT HOLDER**

## BIT HOLDER

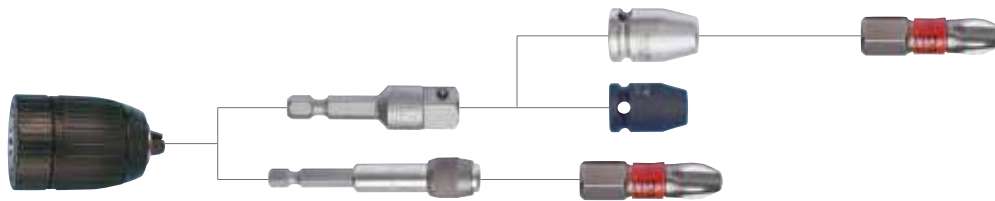



Quick-change holders form a strong connection between the holder and bit. Pushing the clamping bush forward slightly releases the latch

mechanism and facilitates extremely rapid tool replacement.

## MAGNETIC BIT HOLDER, 1/4"



Mount	Length	Version	Art. No.	PU.
1/4" 	150 mm	With guide sleeve	<b>0614 176 639</b>	1
1/4" 	350 mm	With guide sleeve	<b>0614 176 645</b>	1

## BIT HOLDER WITH ADAPTER, 1/4"



**Art. No. 0614 176 636**

- By simply sliding, the sleeve can be used as a socket wrench adapter and a bit holder
- Blade holder 1/4 inch E 6.3 for 1/4 inch square socket wrench inserts or 1/4 inch hexagon
- **Mount E 6.3 (1/4 inch)**
- **Mount type:** Outer hexagon
- **Tip size:** 1/4 inch
- **Tip type:** Internal hexagon socket and outer square
- **Sleeve diameter:** 13 mm
- **Blade length:** 26 mm
- **Length 60 mm**

**BIT DRILL HOLDER, 1/4"**

**Art. No. 0614 176 760**
**Sleeve with non-slip zone**

Easy, one-handed operation, no slipping when opening and closing the holder.

- **Mount E 6.3 (1/4 inch)**
- **Mount type:** Outer hexagon
- **Tip size:** 1/4 inch
- **Tip type:** Internal hexagon socket
- **Sleeve diameter:** 15 mm
- **Length 60 mm**

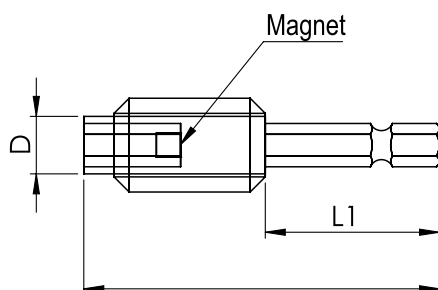
**BIT HOLDER, 1/4"**

**Art. No. 0614 176 755**

- Bit engages automatically
- Spring mechanism makes changing bit easier

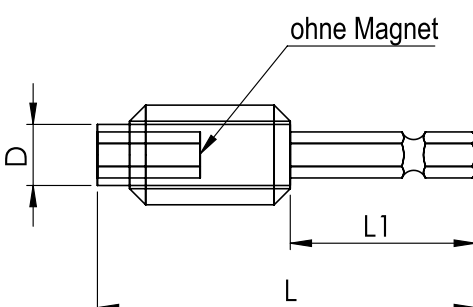
- **Mount E 6.3 (1/4 inch)**
- **Mount type:** Outer hexagon
- **Tip size:** 1/4 inch
- **Tip type:** Internal hexagon socket
- **Sleeve diameter:** 15 mm
- **Blade length:** 20 mm
- **Length 51 mm**

**BIT HOLDER, 1/4"**

**Art. No. 0614 176 756**

- Bit engages automatically
- Spring mechanism makes changing bit easier

- **Mount E 6.3 (1/4 inch)**
- **Mount type:** Outer hexagon
- **Tip size:** 1/4 inch
- **Tip type:** Internal hexagon socket
- **Sleeve diameter:** 15 mm
- **Blade length:** 20 mm
- **Length 51 mm**

## BIT HOLDER

### UNIVERSAL HOLDER WITH QUICK-CHANGE CHUCK, PERMANENT MAGNET



Mount 1/4" E6.3



Mount	Length	Suitable for the following power tools	Art. No.	PU.
1/4"	74 mm	Würth, Bosch, Skil, Atlas Copco, Ingersoll, Hitachi, Makita, AEG, Metabo, Black & Decker, Deprag	<b>0614 176 688</b>	1



Mount 1/4" E6.3

Mount	Length	Suitable for the following power tools	Art. No.	PU.
1/4"	75 mm	Würth, Bosch, Skil, Atlas Copco, Ingersoll, Hitachi, Makita, AEG, Metabo, Black & Decker, Deprag	<b>0614 176 708</b>	1



SDS-plus mount

Mount	Length	Suitable for the following power tools	Art. No.	PU.
1/4"	80 mm	Hammer drills with SDS-plus adaptor	<b>0614 176 701</b>	1



Mount 5.5 mm

Mount	Length	Suitable for the following power tools	Art. No.	PU.
1/4"	72 mm	AEG, Fein, Kress, Metabo, Bosch, Holz-Her	<b>0614 176 706</b>	1



Mount 7.0 mm

Mount	Length	Suitable for the following power tools	Art. No.	PU.
1/4"	77 mm	Würth, Fein, Baier, AEG	<b>0614 176 707</b>	1



Mount 1/4" E6.3

Mount	Length	Suitable for the following power tools	Art. No.	PU.
1/4"	60 mm	Würth, Bosch, Skil, Atlas Copco, Ingersoll, Hitachi, Makita, AEG, Metabo, Black & Decker, Deprag	<b>0614 811 360*</b>	1

Spacer with adjustable screw-in depth

\*Screws are held securely on the bit thus vertical and horizontal screwing possible without tilting or losing screw  
Particularly suitable for long screws



## BIT HOLDER WITH QUICK-CHANGE CHUCK

**Mount 1/4" E6.3**

Mount	Length	Suitable for the following power tools	Art. No.	PU.
1/4"	74 mm	Würth, Bosch, Skil, Atlas Copco, Ingersoll, Hitachi, Makita, AEG, Metabo, Black & Decker, Deprag	<b>0614 176 689</b>	1

**Mount 1/4" E6.3**

Mount	Length	Suitable for the following power tools	Art. No.	PU.
1/4"	51 mm	Würth, Bosch, Skil, Atlas Copco, Ingersoll, Hitachi, Makita, AEG, Metabo, Black & Decker, Deprag	<b>0614 176 711</b>	1

**Mount 7.0 mm**

Mount	Length	Suitable for the following power tools	Art. No.	PU.
1/4"	51 mm	Würth, Fein, Baier, AEG	<b>0614 176 710</b>	1

## BIT HOLDER WITH SNAP RING

**Mount 1/4" E6.3**

Mount	Length	Suitable for the following power tools	Art. No.	PU.
1/4"	57 mm	Würth, Bosch, Skil, Atlas Copco, Ingersoll, Hitachi, Makita, AEG, Metabo, Black & Decker, Deprag	<b>0614 176 673</b>	1

**5/16" mount**

Mount	Length	Suitable for the following power tools	Art. No.	PU.
1/4"	42 mm	Würth, AEG, Bosch	<b>0614 176 752</b>	1

## BIT HOLDER WITH STAINLESS STEEL SLEEVE AND SNAP RING

**Mount 1/4" E6.3**

Mount	Length	Suitable for the following power tools	Art. No.	PU.
1/4"	74 mm	Würth, Bosch, Skil, Atlas Copco, Ingersoll, Hitachi, Makita, AEG, Metabo, Black & Decker, Deprag	<b>0614 176 729</b>	1

**SDS-plus mount**

Mount	Length	Suitable for the following power tools	Art. No.	PU.
1/4"	74 mm	Hammer drills with SDS-plus adapter	<b>0614 176 728</b>	1

## BIT HOLDER

### BIT HOLDER WITH STAINLESS STEEL SLEEVE, SNAP RING AND PERMANENT RING



Mount 1/4" E6.3

Mount	Length	Suitable for the following power tools	Art. No.	PU.
1/4"	45 mm	Würth, Bosch, Skil, Atlas Copco, Ingersoll, Hitachi, Makita, AEG, Metabo, Black & Decker, Deprag	<b>0614 176 690</b>	1



Mount 1/4" E6.3, dia. max. 10 mm

Mount	Length	Suitable for the following power tools	Art. No.	PU.
1/4"	74 mm	Würth, Bosch, Skil, Atlas Copco, Ingersoll, Hitachi, Makita, AEG, Metabo, Black & Decker, Deprag	<b>0614 176 702</b>	1



Mount 1/4" E6.3, dia. max. 11 mm

Mount	Length	Suitable for the following power tools	Art. No.	PU.
1/4"	74 mm	Würth, Bosch, Skil, Atlas Copco, Ingersoll, Hitachi, Makita, AEG, Metabo, Black & Decker, Deprag	<b>0614 176 699</b>	1



Mount 1/4" E6.3

Mount	Length	Suitable for the following power tools	Art. No.	PU.
1/4"	58 mm	Würth, Bosch, Skil, Atlas Copco, Ingersoll, Hitachi, Makita, AEG, Metabo, Black & Decker, Deprag	<b>0614 176 683</b>	1



Mount 1/4" E6.3

Mount	Length	Suitable for the following power tools	Art. No.	PU.
1/4"	51 mm	Würth, Bosch, Skil, Atlas Copco, Ingersoll, Hitachi, Makita, AEG, Metabo, Black & Decker, Deprag	<b>0614 176 697</b>	1



Mount 5.5 mm

Mount	Length	Suitable for the following power tools	Art. No.	PU.
1/4"	72 mm	AEG, Fein, Kress, Metabo, Bosch, Holz-Her	<b>0614 176 674</b>	1



Mount 7.0 mm

Mount	Length	Suitable for the following power tools	Art. No.	PU.
1/4"	74 mm	Würth, Fein, Baier, AEG	<b>0614 176 672</b>	1

### UNIVERSAL BIT HOLDER, 1/4"



Length	Art. No.	PU.
45 mm	<b>0614 176 690</b>	1
50 mm	<b>0614 176 754</b>	1
74 mm	<b>0614 176 699</b>	1
74 mm	<b>0614 176 702</b>	1
175 mm	<b>0614 176 758</b>	1

- **Mount:** E 6.3 (1/4 inch)
- **Mount type:** Outer hexagon
- **Tip size:** 1/4 inch
- **Tip type:** Internal hexagon socket



# **CONNECTION PIECES & SOCKET WRENCH BLADES**

## CONNECTION PIECES DIN 7428

**Mount 1/4" E6.3**

Mount	Length	Suitable for the following power tools	Art. No.	PU.
1/4"	50 mm	Würth, Bosch, Skil, Atlas Copco, Ingersoll, Hitachi, Makita, AEG, Metabo, Black & Decker, Deprag	<b>0614 176 726</b>	1

**Mount 1/4" E6.3**

Mount	Length	Suitable for the following power tools	Art. No.	PU.
1/4"	25 mm	Würth, Bosch, Skil, Atlas Copco, Ingersoll, Hitachi, Makita, AEG, Metabo, Black & Decker, Deprag	<b>0614 176 700</b>	1

**Mount 7.0 mm**

Mount	Length	Suitable for the following power tools	Art. No.	PU.
1/4"	75 mm	Würth, Fein, Baier, AEG	<b>0614 923 130</b>	1

**Mount 7.0 mm**

Mount	Length	Suitable for the following power tools	Art. No.	PU.
1/4"	53 mm	Würth, Fein, Baier, AEG	<b>0614 923 131</b>	1

**Mount 1/4" E6.3**

Mount	Length	Suitable for the following power tools	Art. No.	PU.
3/8"	50 mm	Würth, Bosch, Skil, Atlas Copco, Ingersoll, Hitachi, Makita, AEG, Metabo, Black & Decker, Deprag	<b>0614 176 727</b>	1

**5/16" mount**

Mount	Length	Suitable for the following power tools	Art. No.	PU.
3/8"	50 mm	Würth, AEG, Bosch	<b>0614 176 705</b>	1

**Mount 1/4" E6.3**

Mount	Length	Suitable for the following power tools	Art. No.	PU.
1/2 inch	74 mm	Würth, Bosch, Skil, Atlas Copco, Ingersoll, Hitachi, Makita, AEG, Metabo, Black & Decker, Deprag	<b>0614 176 780</b>	1

**SDS-plus mount**

Mount	Length	Suitable for the following power tools	Art. No.	PU.
1/2"	74 mm	Numerous hammer drills	<b>0614 176 782</b>	1

**Mount 7.0 mm**

Mount	Length	Suitable for the following power tools	Art. No.	PU.
1/2 inch	75 mm	Würth, Fein, Baier, AEG	<b>0614 176 781</b>	1

**Mount 10 mm**

Mount	Length	Suitable for the following power tools	Art. No.	PU.
1/4"	22 mm	Würth, Bosch, Skil, Atlas Copco, Ingersoll, Hitachi, Makita, AEG, Metabo, Black & Decker, Deprag	<b>0715 11 02</b>	1

## CONNECTION PIECES AND SOCKET WRENCH BLADES

### CONNECTION PIECES DIN 7427



1/4" bit mount



Mount	Length	Art. No.	PU.
1/4" square head	25 mm	<b>0614 176 680</b>	1



5/16" bit mount



Mount	Length	Art. No.	PU.
1/4" square head	25 mm	<b>0695 177 982</b>	1



1/4" bit mount



Mount	Length	Art. No.	PU.
3/8" square head	30 mm	<b>0614 176 681</b>	1



10 mm bit mount



Mount	Length	Art. No.	PU.
3/8" square head	29 mm	<b>0715 12 02</b>	1



5/16" bit mount



Mount	Length	Art. No.	PU.
3/8" square head	30 mm	<b>0614 176 682</b>	1



1/4" bit mount



Mount	Length	Art. No.	PU.
1/2" square head	35 mm	<b>0614 215 013</b>	1



5/16" bit mount



Mount	Length	Art. No.	PU.
1/2" square head	35 mm	<b>0614 215 010</b>	1



10 mm bit mount



Mount	Length	Art. No.	PU.
1/2" square head	37 mm	<b>0715 13 03</b>	1

### SOCKET WRENCH BLADES HEXAGON SOCKET WRENCH, 7 MM, WITH MAGNET

- Power tool chuck, 7 mm dia.
- Screw mount: see table
- Length: 51 mm

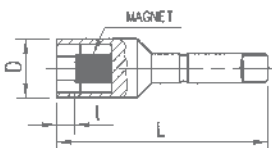

Drive	for M thread	D	l	Weight	Art. No.	PU.
7 mm	4	11 mm	2.8 mm	23 g	<b>0614 176 721</b>	1
8 mm	5	12 mm	3.5 mm	23 g	<b>0614 176 722</b>	1
3/8"	-	14 mm	4.2 mm	30 g	<b>0614 176 723</b>	1
10 mm	6	14 mm	4.2 mm	30 g	<b>0614 176 724</b>	1
13 mm	8	18 mm	6.0 mm	38 g	<b>0614 176 725</b>	1

### SOCKET WRENCH BLADES HEXAGON SOCKET WRENCH, 5/16" WITH MAGNET

- Power tool chuck 5/16" C8.0
- Screw mount: see table
- Length: 50 mm



Drive	Screw dia.	D	l	Weight	Art. No.	PU.
12 mm	8	20 mm	5.5 mm	60 g	<b>0614 176 831</b>	1
15 mm	10	23 mm	9.5 mm	69 g	<b>0614 176 832</b>	1
17 mm	12	25 mm	10 mm	74 g	<b>0614 176 833</b>	1

**SOCKET WRENCHES**
**SOCKET WRENCH BLADES HEXAGON SOCKET WRENCH, 1/4" WITH MAGNET**

- Power tool chuck 1/4" E6.3
- Screw mount: see table
- Length: 51 mm

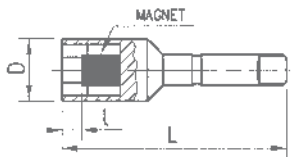

Drive	for M thread	D	l	Weight	Art. No.	PU.
5.5 mm	3	9 mm	2.1 mm	18 g	<b>0614 176 712</b>	1
1/4"	-	10 mm	1.8 mm	20 g	<b>0614 176 713</b>	1
7 mm	4	11 mm	2.8 mm	22 g	<b>0614 176 714</b>	1
8 mm	5	12 mm	3.5 mm	22 g	<b>0614 176 715</b>	1
3/8"	-	14 mm	4.2 mm	29 g	<b>0614 176 716</b>	1
10 mm	6	14 mm	4.2 mm	29 g	<b>0614 176 717</b>	1
13 mm	8	18 mm	6.0 mm	39 g	<b>0614 176 718</b>	1

**SOCKET WRENCH BLADES HEXAGON SOCKET WRENCH, 1/4"**

- Power tool chuck 1/4" E6.3
- Screw mount: see table
- Length: 65 mm

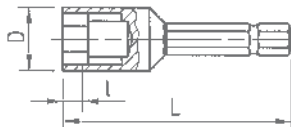

Drive	for M thread	D	l	Weight	Art. No.	PU.
7 mm	4	11 mm	5 mm	18 g	<b>0614 176 811</b>	1
8 mm	5	12 mm	6 mm	20 g	<b>0614 176 812</b>	1
10 mm	6	14 mm	7 mm	22 g	<b>0614 176 813</b>	1
3/8"	-	14 mm	7 mm	33 g	<b>0614 176 820</b>	1

**SOCKET WRENCH BLADES HEXAGON SOCKET WRENCH, 1/4"**

- Power tool chuck 1/4" E6.3
- With ball mount
- Screw mount: see table
- Length: 50 mm (SW 10 mm),  
Length: 65 mm (SW 13 mm)

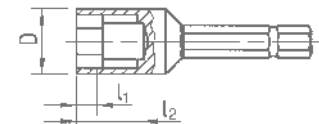

**For Varibos self-drilling screw**

Drive	for M thread	D	l	Weight	Art. No.	PU.
10 mm	6	16.0 mm	6.5 mm	18 g	<b>0614 176 824</b>	1
13 mm	8	19.5 mm	8.0 mm	19 g	<b>0614 176 825</b>	1

# BITS & ACCESSORIES

## Small bits, big impact

### **Wuerth Industrial Services Malaysia Sdn. Bhd.**

Lot 806, Jalan Subang 5  
Taman Perindustrian Subang  
47600 Subang Jaya, Selangor  
Phone +60 3 8021 0200  
info@wuerth-industry.my  
www.wuerth.my

### **Wuerth Industrial (Penang) Sales Office**

16-1C Menara Boustead  
39 Jalan Sultan Ahmad Shah  
10050 Georgetown, Penang  
Phone +60 4 228 9200  
office\_penang@wuerth-industry.my  
www.wuerth.my

Reproduction only with permission.  
MWC - DNP/SF - ZPPD - 150 - 02/19  
Printed on environmentally friendly paper.

We reserve the right to make any changes we deem necessary to improve the quality of the product, even without prior announcement or notification. Illustrations may be example illustrations that may differ in appearance from the goods supplied. Errors excepted. We accept no liability for any printing errors.  
Our general terms and conditions apply.

